

節亮康復產品有限公司產品手冊

Health Product

Your Smart Health Care Solution Partners
Health care product | Smart home care | Air purification

Health Test Meter

Z13

Ziglite Smart Health Care Products Co., Ltd.





Z IGLITE[®]
HEALTHCARE



Company Profile

公司簡介

ABOUT US 關於我們

Ziglite Smart Health Care Products Co., Ltd. Incorporated in 2018, we work with our partners to bring their products to the local market. Mainly engaged in the management of health care products, the main customers are hospitals and clinics, homes for the elderly and home patients.

We are committed to the development of excellent health care products, dedicated to the needs of a wide range of different customers, get the best care in the family treatment process, and greatly improve the effect of rehabilitation. Get the best care during the family treatment process and greatly improve the healing effect. We will provide quality products with stable quality and stable performance for customers.

We specialize in a wide range of products including: anti-virus and air freshening, incontinence care, mobility aids, decompression supplies, etc.

what's inside...

PRODUCT CATALOG

公司於2018年成立，我們與合作夥伴一起把他們的產品推向本地市場。以經營康護用品為主，主要客戶為醫院及診所，安老院及家居病人等。

我們致力於發展卓越的康護醫療產品，竭誠照顧廣大不同客戶的需要，在家庭治療過程中得到最好的護理，大大提高康復治療效果。在家庭治療過程中得到最好的護理，大大提高康復治療效果。務求為客戶提供品質優越及性能穩定的醫療產品。

我們專營的產品種類繁多，包括：抗病毒及空氣清新，失禁護理，助行用品，減壓用品等。



Posture Cushion 體位墊



NAO P02



NAN P03



NAM P04

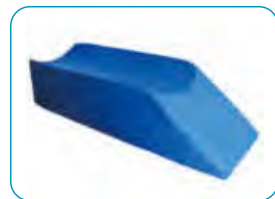

NAL P05



NAK P06



NAJ P07



NAI P08



NAX P09

Limb Fixation 肢體固定



NAR P11



NAE P12

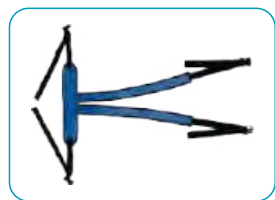

NDF P13



NAP P14



NAQ P15



NBC P16



NBD P17

Life Nursing 生活護理



NAV P19



NAD P20



NBE P21



NBY P22



NAB P23



NBZ P24



NDA P25



NBF P26



NDK P27



NDI P28



NDM P29



NDJ P30



NDP P31



NDN P32



NDO P33



WBF P34



NBB P35



NBH P36



NAH P37



NBV P38



NDE P39



NBU P40



NDD P41



NBP P42



NBA P43



NBN P44



NBO P45

Incontinence Nursing 失禁護理



NAF P47

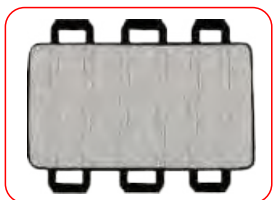

NBX P48



NAC P49



NAA P50



NAS P51



NAU P52



NAZ P53



NBI P54



NBJ P55



NBK P56



NBL P57



NDH P58

Baby Nursing 嬰兒護理



NCA P60



NCB P61



NCC P62



NCD P63



NCE P64



NCF P65

Medical Tools 醫用工具



NDB P67



NDC P68



NDG P69



NDQ P70



NDR P71



NDS P72

Posture Cushion

體位墊



Cylindrical Scaffold Sponge Pad

圓柱腳手圈海綿支撐墊

Model: NAO

Features:

- The cylindrical design effectively supports the affected area
- High-density sponge material is soft and comfortable, safer to use
- Function: protect the wrist and ankle
- Applicable crowd: people with hand and foot injuries
- 圓柱設計有效支撐患部
- 高密度海綿材質, 柔軟舒適, 使用更安全
- 功能: 保護手腕部和腳踝部
- 適用人群: 手腳受傷人士



Specifications

Product Model 產品型號	NAO
Product Material 產品材質	high-density sponge, cotton cloth 高密度海綿, 棉布
Product Function 產品功能	Hand support, foot support 手部支撐、腳部支撐
Color 顏色	blue white 藍色, 白色
Product Size 產品尺寸	15*6*10cm
Product Weight 產品重量	46g
Packing Size 包裝尺寸	22*15*12cm
Package Weight 包裝重量	0.12kg

Instructions

- ◆ 將產品取出後用在相應部位即可

注意事項:

- ◆ 此款為棉質產品請遠離火源或高溫環境。以免造成產品損壞, 以防影響使用壽命
- ◆ 遠離潮濕環境, 以免滋生細菌

Concave Multipurpose Sponge Ankle Pad

凹形多用海綿墊-踝骨墊

Model: NAN

Features:

- Hidden zipper design, easy to take apart and wash, simple and practical appearance does not affect the use
- U-shaped design effectively supports the affected area
- High-density sponge material is soft and comfortable, safer to use
- Function: Elevate the neck, wrist or ankle for more comfort
- Applicable crowd: people who need long-term or short-term bed rest
- 隱藏式拉鍊設計, 方便拆洗, 外形簡單實用
- U型設計有效支撐患部
- 高密度海綿材質, 柔軟舒適, 使用更安全
- 功能: 抬高頸部、腕部或者腳踝處, 更舒適
- 適用人群: 需要長期或短期臥床的人士

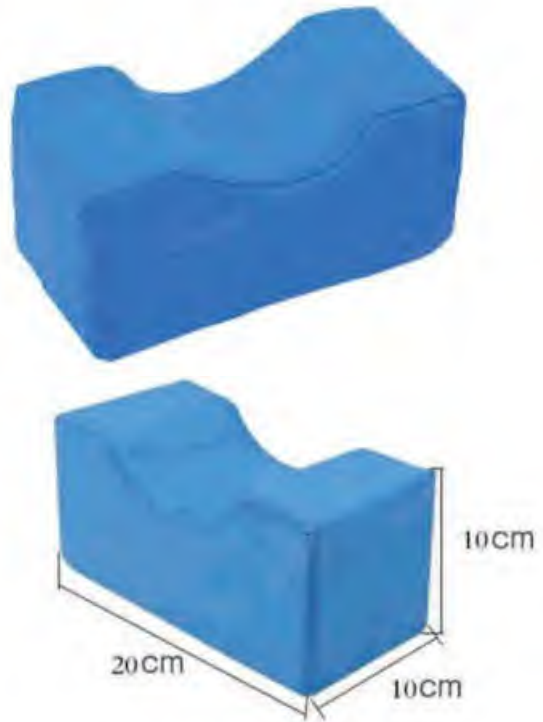

Specifications

Product Model 產品型號	NAN
Product Material 產品材質	high-density sponge, cotton cloth 高密度海綿, 棉布
Product Function 產品功能	elevate the neck, wrist or ankle 抬高頸部、腕部或者腳踝處
Color 顏色	blue 藍色
Product Size 產品尺寸	20*10*10cm
Product Weight 產品重量	42g
Packing Size 包裝尺寸	22*15*12cm
Package Weight 包裝重量	0.11kg

Instructions

- ◆ 將產品取出後用在相應部位即可
- ◆ 將側面拉鍊拉開取出海綿即可清洗

注意事項:

- ◆ 此款為棉質產品請遠離火源或高溫環境。以免造成產品損壞, 以防影響使用壽命
- ◆ 遠離潮濕環境, 以免滋生細菌

S-shaped Leg Raising Roll Over Pad

S形腿部抬高翻身墊

Model: NAM

Features:

- Hidden zipper design, easy to take apart and wash, simple and practical appearance does not affect the use
- The S-shaped design effectively supports the affected area
- High-density sponge material is soft and comfortable, safer to use
- Function: Elevate the lower limbs 15cm and keep the lower limbs physiologically bent
- Applicable crowd: people who need long-term or short-term bed rest
- 隱藏式拉鍊設計, 方便拆洗, 外形簡單實用
- S型設計有效支撐患部
- 高密度海綿材質, 柔軟舒適, 使用更安全
- 功能: 抬高下肢15cm並保持下肢生理彎曲
- 適用人群: 需要長期或短期臥床的人士

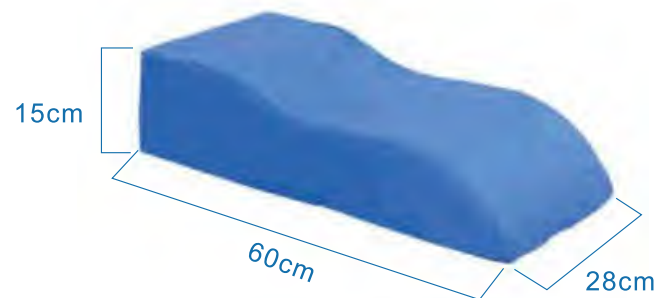

Specifications

Product Model 產品型號	NAM
Product Material 產品材質	high-density sponge, cotton cloth 高密度海綿, 棉布
Product Function 產品功能	elevate the lower limbs 抬高下肢
Color 顏色	blue 藍色
Product Size 產品尺寸	60*28*15cm
Product Weight 產品重量	500g
Packing Size 包裝尺寸	54*28*23.5cm
Package Weight 包裝重量	1.00kg

Instructions

- ◆ 將產品取出後用在相應部位即可
- ◆ 將側面拉鍊拉開取出海綿即可清洗

注意事項:

- ◆ 此款為棉質產品請遠離火源或高溫環境。以免造成產品損壞, 以防影響使用壽命
- ◆ 遠離潮濕環境, 以免滋生細菌

Leg Raising Pad

腿部抬高下肢墊

Model: NAL

Features:

- Hidden zipper design, easy to take apart and wash, simple and practical appearance does not affect the use
- Shallow U-shaped design effectively supports the affected area
- High-density sponge material is soft and comfortable, safer to use
- Function: Provide support for leg discomfort
- Applicable crowd: people who need long-term or short-term bed rest
- 隱藏式拉鍊設計, 方便拆洗, 外形簡單實用
- 淺U型設計有效支撐患部
- 高密度海綿材質, 柔軟舒適, 使用更安全
- 功能: 提供腿部下肢不適的支撐
- 適用人群: 需要長期或短期臥床的人士

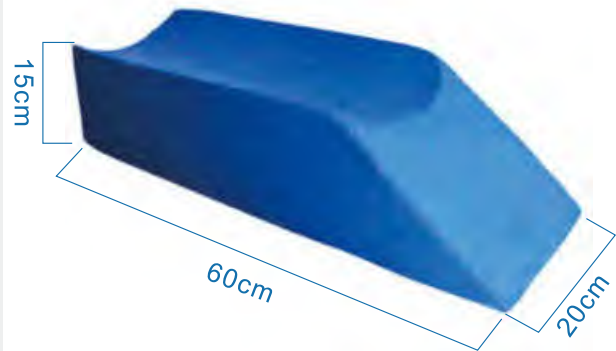

Specifications

Product Model 產品型號	NAL
Product Material 產品材質	high-density sponge, cotton cloth 高密度海綿, 棉布
Product Function 產品功能	support legs 支撐腿部
Color 顏色	blue 藍色
Product Size 產品尺寸	50*20*15cm
Product Weight 產品重量	485g
Packing Size 包裝尺寸	54*28*23.5cm
Package Weight 包裝重量	0.99kg

Instructions

- ◆ 將產品取出後用在相應部位即可
- ◆ 將側面拉鍊拉開取出海綿即可清洗

注意事項:

- ◆ 此款為棉質產品請遠離火源或高溫環境。以免造成產品損壞, 以防影響使用壽命
- ◆ 遠離潮濕環境, 以免滋生細菌

Triangle Position Lifting Turning Pad

三角體位抬高翻身墊

Model: NAK

Features:

- Hidden zipper design, easy to take apart and wash, simple and practical appearance does not affect the use
- Triangular design effectively supports the affected area
- High-density sponge material is soft and comfortable, safer to use
- Function: Provide support for hand or wrist injury
- Applicable crowd: people who need long-term or short-term bed rest
- 隱藏式拉鍊設計, 方便拆洗, 外形簡單實用
- 三角型設計有效支撐患部
- 高密度海綿材質, 柔軟舒適, 使用更安全
- 功能: 提供手部或者手腕受傷時支撐
- 適用人群: 需要長期或短期臥床的人士

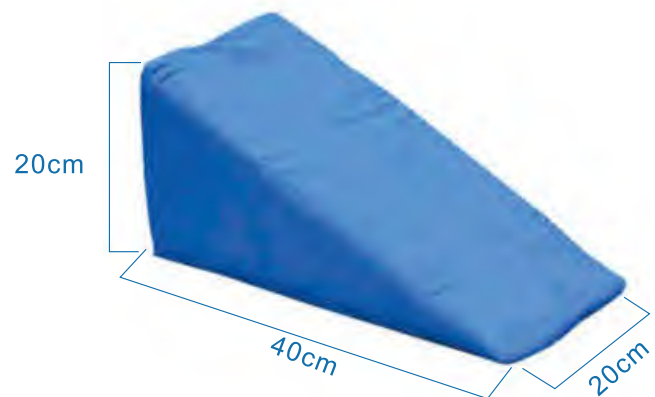

Specifications

Product Model 產品型號	NAK
Product Material 產品材質	high-density sponge, cotton cloth 高密度海綿, 棉布
Product Function 產品功能	support wrist and forearm 支撐手腕、前臂
Color 顏色	blue 藍色
Product Size 產品尺寸	40*20*20cm
Product Weight 產品重量	207g
Packing Size 包裝尺寸	44*26*22cm
Package Weight 包裝重量	0.64kg

Instructions

- ◆ 將產品取出後用在相應部位即可
- ◆ 將側面拉鍊拉開取出海綿即可清洗

注意事項:

- ◆ 此款為棉質產品請遠離火源或高溫環境。以免造成產品損壞, 以防影響使用壽命
- ◆ 遠離潮濕環境, 以免滋生細菌

Triangular Upper Limb Side Pad

三角康復上肢側身墊

Model: NAJ

Features:

- Hidden zipper design, easy to take apart and wash, simple and practical appearance does not affect the use
- Triangular design effectively supports the affected area
- High-density sponge material is soft and comfortable, safer to use
- Function: Provide support in lateral and prone positions
- Applicable crowd: people who need long-term or short-term bed rest
- 隱藏式拉鍊設計, 方便拆洗, 外形簡單實用
- 三角型設計有效支撐患部
- 高密度海綿材質, 柔軟舒適, 使用更安全
- 功能: 提供側臥位及俯臥位時的支撐
- 適用人群: 需要長期或短期臥床的人士

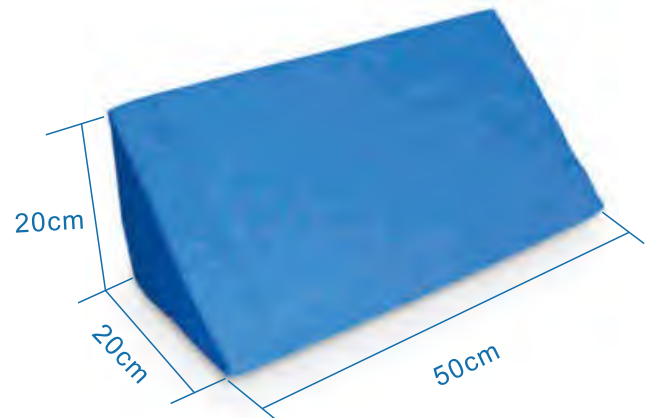

Specifications

Product Model 產品型號	NAJ
Product Material 產品材質	high-density sponge, cotton cloth 高密度海綿, 棉布
Product Function 產品功能	support waist 支撐腰部
Color 顏色	blue 藍色
Product Size 產品尺寸	50*20*20cm
Product Weight 產品重量	480g
Packing Size 包裝尺寸	54*28*23.5cm
Package Weight 包裝重量	0.96kg

Instructions

- ◆ 將產品取出後用在相應部位即可
- ◆ 將側面拉鍊拉開取出海綿即可清洗

注意事項:

- ◆ 此款為棉質產品請遠離火源或高溫環境。以免造成產品損壞, 以防影響使用壽命
- ◆ 遠離潮濕環境, 以免滋生細菌

R-type Upper Limb Side Body Pad

R型上肢側身墊

Model: NAI

Features:

- Hidden zipper design, easy to take apart and wash, simple and practical appearance does not affect the use
- R-shaped design effectively supports the affected area
- High-density sponge material is soft and comfortable, safer to use
- Function: Provide support in lateral and prone positions
- Applicable crowd: people who need long-term or short-term bed rest
- 隱藏式拉鍊設計, 方便拆洗, 外形簡單實用
- R型設計有效支撐患部
- 高密度海綿材質, 柔軟舒適, 使用更安全
- 功能: 提供側臥位及俯臥位時的支撐
- 適用人群: 需要長期或短期臥床的人士

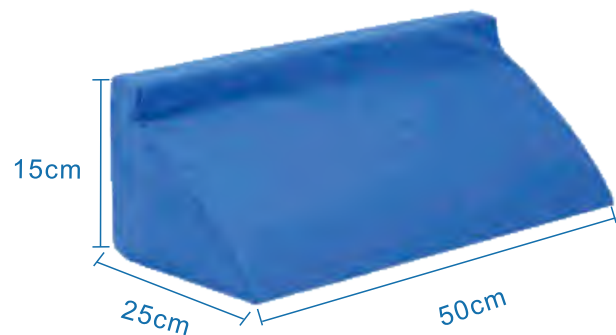

Specifications

Product Model 產品型號	NAI
Product Material 產品材質	high-density sponge, cotton cloth 高密度海綿, 棉布
Product Function 產品功能	provide support in lateral and prone positions 提供側臥位及俯臥位時的支撐
Color 顏色	blue 藍色
Product Size 產品尺寸	50*25*15cm
Product Weight 產品重量	490g
Packing Size 包裝尺寸	54*28*23.5cm
Package Weight 包裝重量	0.99kg

Instructions

- ◆ 將產品取出後用在相應部位即可
- ◆ 將側面拉鍊拉開取出海綿即可清洗

注意事項:

- ◆ 此款為棉質產品請遠離火源或高溫環境。以免造成產品損壞, 以防影響使用壽命
- ◆ 遠離潮濕環境, 以免滋生細菌

Turn Over Auxiliary Pad

臥床翻身輔助器

Model: NAX

Features:

- Waterproof Pu fabric is adopted, which is waterproof, easy to take care of and easy to use
- High quality sponge lining, comfortable, soft, strong and durable
- Integrated zipper design, beautiful appearance, easy to disassemble and wash
- It can be stuck in a wheelchair to help patients unload their strength (not applicable for obese people)
- Applicable scenario: the assistant turns over and takes care when turning over. It can be fixed on the wheelchair to relieve the patient
- 採用防水PU面料, 防水易打理, 使用方便
- 優質海綿內裡, 舒適柔軟, 結實耐用
- 一體式拉鍊設計, 外形美觀, 方便拆洗
- 可卡在輪椅上, 幫忙患者卸力(肥胖者不適用)
- 適用場景: 助理翻身以及翻身時進行護理, 可以固定在輪椅上讓患者卸力

Specifications

Product Model 產品型號	NAX
Product Material 產品材質	PU leather + rebound cotton PU皮+回彈棉
Product Function 產品功能	roll over assist 翻身輔助
Color 顏色	blue, green 藍色, 綠色
Product Size 產品尺寸	45*40*12cm
Product Weight 產品重量	550g
Packing Size 包裝尺寸	47*42*14.5cm
Package Weight 包裝重量	0.75kg

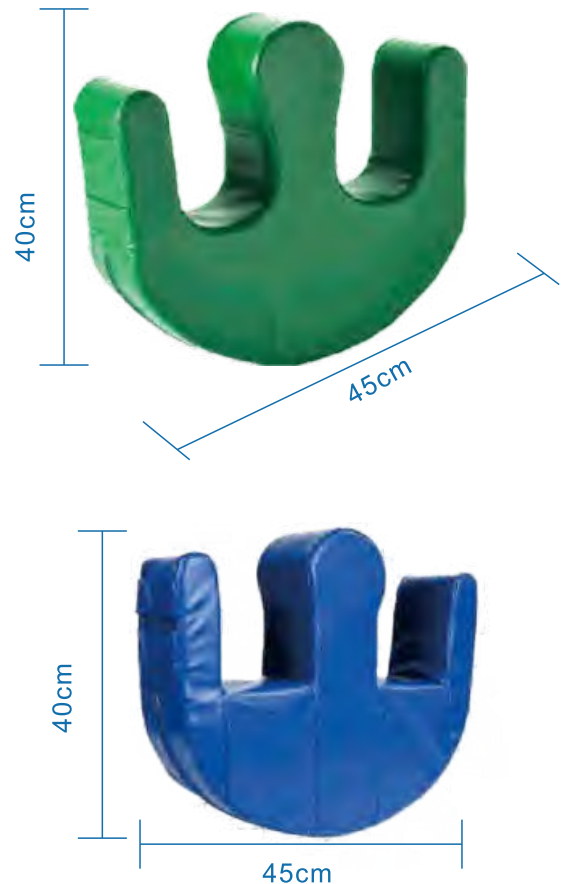

Instructions

- ◆ 將產品取出後用在相應部位即可
- ◆ 將側面拉鍊拉開取出海綿即可清洗

注意事項:

- ◆ 皮膚過敏者慎用
- ◆ 對產品材料過敏者慎用
- ◆ 應存放於乾燥和通風良好的室內, 勿於酸鹼等腐蝕性物質混放
- ◆ 遠離高熱、火源等環境
- ◆ 產品只可擦洗, 不可機洗

Limb Fixation

肢體固定



Medical Wheelchair Safety Strap

醫用輪椅安全固定帶

Model: NAR

Features:

- Curved appearance design, sturdy internal structure, self-locking to prevent the webbing from slipping off
- Comfortable, breathable, moisture-absorbing, heat-resistant, durable, clean-resistant, soft and smooth, firm and strong
- Filled with sponge, no mark, no restraint
- Precise tailoring, workmanship, ergonomic principles, and physiological characteristics
- Applicable crowd: people who need to be fixed in wheelchairs
- 弧形外觀設計, 內部結構堅固, 自鎖防止織帶滑落
- 舒適、透氣、吸濕、耐熱、耐用、耐清潔、柔軟光滑、牢固
- 填塞海綿, 無痕迹, 無束縛
- 精確的剪裁、工藝、人體工程學原理和生理特性
- 適用人群: 坐輪椅需要固定的人士

Specifications

Product Model 產品型號	NAR
Product Material 產品材質	high elastic sponge 高彈力海綿
Product Function 產品功能	prevent patients from leaning forward and falling down 預防患者前傾、跌倒
Product Size 產品尺碼	one size 均碼
Color 顏色	green 綠
Product Size 產品尺寸	18*29*5cm
Product Weight 產品重量	325g
Package Size 包裝尺寸	30*21.5*5cm
Packing Weight 包裝重量	0.45kg

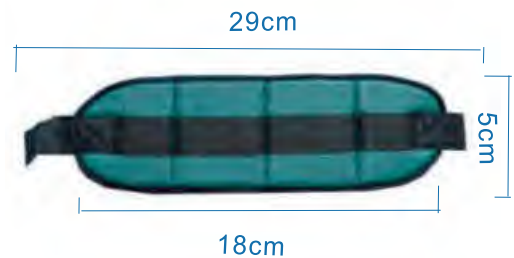

Instructions

◆ 把輪椅安全帶放置在病人胸前, 織帶從病人腋下穿過至輪椅後方, 把插扣扣上即可

注意事項:

- ◆ 此款為棉質產品請遠離火源或高溫環境。以免造成產品損壞, 以防影響使用壽命
- ◆ 遠離潮濕環境, 以免滋生細菌
- ◆ 嚴格避免與鋒利、尖銳的物體及腐蝕性溶液接觸
- ◆ 在固定時請注意鬆緊, 以免固定太緊或太鬆造成不必要的傷害

Elastic Fixed Wheelchair Safety Belt

彈性固定輪椅安全帶

Model: NAE

Features:

- Velvet perforated and breathable mesh fabric does not hurt the skin
- The shoulder strap is made of elastic OK cloth, which effectively cushions the danger of bumps
- It adopts snap-on connection and can be adjusted
- The shoulders are fixed by Velcro, and the elasticity can be adjusted
- Purpose: Prevent the patient from tilting and falling over
- Applicable crowd: people who need to be fixed in wheelchairs

- 天鵝絨打孔透氣網布, 不傷皮膚
- 肩帶採用彈性OK布, 有效緩衝顛簸時產生的衝擊力
- 採用卡扣式連接, 可調節
- 雙肩採用魔术貼固定, 可調節鬆緊
- 用途: 防止病人傾斜翻到和摔跤
- 適用人群: 坐輪椅需要固定的人士



腰圍90-150cm

Specifications

Product Model 產品型號	NAE
Product Material 產品材質	velvet perforated cloth + OK cloth 天鵝絨孔布+OK布
Product Function 產品功能	anti dumping 防傾倒
Specifications 規格	average code adjustable 均碼可調節
Product Color 產品顏色	blue+black 藍+黑
Waist Size 腰圍尺寸	90-150cm
Storage Size 收納尺寸	16*10*10cm
Product Weight 產品重量	176g
Package Size 包裝尺寸	20*10*10cm
Packing Weight 包裝重量	0.23kg

Instructions

- ◆ 將腰帶從前面繞過輪椅, 在輪椅後面扣好, 調節鬆緊
- ◆ 將肩帶沿著雙肩穿過輪椅推手返回來粘貼好即可

注意事項:

- ◆ 請遠離火源或高溫環境, 以免造成產品損壞, 防止影響使用壽命
- ◆ 請遠離潮濕環境, 以免滋生細菌
- ◆ 可用清水和洗滌劑清洗, 不要用腐蝕性液體等

Wheelchair Safety Restraint Belt

輪椅安全約束帶

Model: NDF

Features:

- Sewed with thick nylon thread, the cross fixing is more solid
- Thickened fastener, safe use of quality
- Encrypted nylon webbing, strong security
- 加粗尼龍線縫製, 十字固定更結實
- 加厚扣具, 品質放心使用
- 加密尼龍織帶, 安全性強

Specifications

Product Model 產品型號	NDF
Product Material 產品材質	breathable mesh 透氣網
Product Function 產品功能	prevent patients from leaning forward and falling down 預防患者前傾、跌倒
Product Size 產品尺碼	one size 均碼
Color 顏色	blue 藍色
Product Size 產品尺寸	腰部:長約180cm,襠部:長約115cm waist length: ≈180cm crotch length: ≈115cm
Product Weight 產品重量	180g
Package Size 包裝尺寸	25*17*5cm
Packing Weight 包裝重量	0.26kg

腰部:長約180cm



Instructions

- ◆ 準備好約束帶
- ◆ 然後把綁帶串到椅子上, 扣上安全扣, 可根據個人使用調節長度
- ◆ 將綁帶串過大腿繞至椅子背部, 扣上安全扣, 可根據個人使用調節長度

注意事項:

- ◆ 此款為棉質產品請遠離火源或高溫環境。以免造成產品損壞, 以防影響使用壽命
- ◆ 遠離潮濕環境, 以免滋生細菌
- ◆ 嚴格避免與鋒利、尖銳的物體及腐蝕性溶液接觸
- ◆ 在固定時請注意鬆緊, 以免固定太緊或太鬆造成不必要的傷害

Fixed Gloves For Limb Rehabilitation

肢體復康固定手套

Model: NAP

Features:

- Breathable mesh, elastic rubber sheet, four-layer flannel, good comfort
- Adding cotton soft pads to make the wrist pressure filling and decompression, avoiding damage to the hands
- The zipper opening design is conducive to clinical nurses to observe the user's situation and is used for the detection of blood oxygen saturation
- Applicable population: suitable for patients who are confused, irritable, and have self-harm behavior
- 吸濕柔軟透氣網布, 彈性膠板, 四層絨布, 舒適度好
- 加棉軟墊使腕部受力填充減壓, 避免綁帶給皮膚帶來傷害
- 拉鏈開口設計, 可以當封口使用利於臨床護士觀察使用者情況, 用於血氧飽和度的檢測
- 適用人群: 適用神志模糊、煩躁不安、有自傷行為治療性的病人, 為虛弱無力患者保護手部組織損傷固定



Specifications

Product Model 產品型號	NAP
Product Material 產品材質	mesh / cushion coated rubber sheet 網布/軟墊裹覆膠板
Product Function 產品功能	protect hands from injury 保護手部損傷
Wrist Width 手腕寬度	約24-35cm
Palm Width 手掌寬度	約15cm
Product Size 產品尺碼	m 中號
Color 顏色	green 綠
Product Size 產品尺寸	18*29*5cm
Product Weight 產品重量	325g
Package Size 包裝尺寸	30*21.5*5cm
Packing Weight 包裝重量	0.45kg

Instructions

◆ 手部套進手套, 固定腕部, 再用綁帶固定到床上或者輪椅等其他支撐物上

注意事項:

- ◆ 嚴格避免與鋒利、尖銳的物體及腐蝕性溶液接觸
- ◆ 為避免交叉感染, 約束手套不可在病人間交叉使用, 並定期對約束手套進行清洗和消毒
- ◆ 使用前檢查約束手套各個部位是否牢固, 有無破損等
- ◆ 用含氯消毒液清洗浸泡時間不得超過30分鐘
- ◆ 每拉伸固定2小時請適當的休息15-30分鐘

Ankle Rehabilitation Fixed Protective Cover

踝關節復康固定保護套

Model: NAQ

Features:

- Adjustable traction belt, can adjust the back bending angle, adjust the comfort angle
- Multiple Velcro design, stable and easy to wear
- Built in fixation plate can effectively support the lower leg, which is stable and comfortable to use
- Built in decompression cotton, built-in protruding sponge in ankle joint, comfortable and strong wrapping
- Applicable crowd: long-term bedridden, lack of lower limb movement, sign of foot drop, elderly and weak
- 可調牽引帶，能調節背曲角度，調整舒適角
- 多條魔术貼設計，固定穩固，且方便穿戴
- 內置固定板，有效支撐小腿，使用穩固、舒適
- 內置減壓棉，踝關節內置凸出海綿，且舒適，包裹性強
- 適用人群：長期臥床病人、下肢缺乏運動的病人、足下垂先兆的病人、年老體弱者



Specifications

Product Model 產品型號	NAQ
Product Material 產品材質	high elastic sponge,twillcotton 高彈力海綿、斜紋棉布
Product Function 產品功能	prevention of lower extremity venous thrombosis 預防下肢靜脈血栓
Product Specifications 產品規格	right and left 左右通用
Product Size 產品尺碼	one size 均碼
Color 顏色	green 綠
Product Size 產品尺寸	40*26*4cm
Product Weight 產品重量	340g
Package Size 包裝尺寸	42*27*21cm
Packing Weight 包裝重量	0.78kg

Instructions

- ◆ 腳套進去，貼上魔术貼，拉緊釦帶即可固定

注意事項：

- ◆ 此款為棉質產品請遠離火源或高溫環境。以免造成產品損壞，以防影響使用壽命
- ◆ 遠離潮濕環境，以免滋生細菌
- ◆ 嚴格避免與鋒利、尖銳的物體及腐蝕性溶液接觸
- ◆ 每拉伸固定2小時請適當的休息15-30分鐘

Adjustable Restraining Belt

可調約束帶安全帶

Model: NBC

Features:

- Prevent from getting up, falling off the bed and rollover. You can turn left and right, and there is room for activity
- Multi purpose bed, wheelchair and can be used
- Polyester cotton material, breathable and comfortable, widened and thickened design, edging technology, firm and durable
- Adjustable length, more convenient to use
- Applicable population: Alzheimer's disease, people in need of restraint and protection, etc

- 防止起身、墜床、側翻可以左右翻身, 有活動空間
- 集多用途於一身床、輪椅、都能使用
- 滌棉材質、透氣舒適, 加寬加厚設計, 包邊工藝, 牢固耐用
- 可調節長度, 使用更方便
- 適用人群: 老年癡呆、需要約束防護等人群



Specifications

Product Model 產品型號	NBC
Product Material 產品材質	polyester cotton + nylon 滌棉+尼龍
Product Function 產品功能	fixed restraint and safety belt 固定約束、安全帶
Product Size 產品尺碼	suitable for bed width within 1.5m 適合1.5M以內床寬
Color 顏色	green 綠
Product Size 產品尺寸	440*14*2cmcm
Product Weight 產品重量	485g
Package Size 包裝尺寸	25.5*20*7cm
Packing Weight 包裝重量	0.612kg

Instructions

- ◆ 準備好約束帶
- ◆ 產品一頭從開口處穿進去
- ◆ 然後把綁帶串到床下或者輪椅上, 扣上安全扣, 可根據個人使用調節長度
- ◆ 固定好後即可開始使用
- ◆ 前面穿孔法, 不想轉身: 穿孔放在身體上方就不能轉身
- ◆ 後背穿孔法, 想轉身: 穿孔放在身下就可以轉身

注意事項:

- ◆ 此款為棉質產品請遠離火源或高溫環境, 以免造成產品損壞, 以防影響使用壽命
- ◆ 遠離潮濕環境, 以免滋生細菌

Restless Patient's Leg About Fixed Belt

躁動病人腿部約固定帶

Model: NBD

Features:

- Polyester cotton material binding belt, strong and durable polyester cotton, will not have a sense of oppression
- Easy to wear, two-step one-time, fast operation
- Body washing is convenient and simple
- Product function: prevent self injury caused by unconsciousness or agitation of bedridden persons
- Applicable to: people in need of postoperative rehabilitation, agitation, mental patients, drug addicts, etc
- 滌棉材質約束帶，堅固耐用滌棉，不會有壓迫感
- 穿戴方便簡單，二步一次搞定，操作快捷
- 體水洗，方便簡單
- 產品作用：防止臥床者無意識或者躁動引起的自傷
- 適用於：術後康復、躁動、精神患者、戒毒人員等需要適用人群束縛人群



Specifications

Product Model 產品型號	NBD
Product Material 產品材質	polyester cotton 滌棉
Product Function 產品功能	anti dumping 肢體固定
Spec 規格	average code adjustable 均碼可調節
Product Color 產品顏色	dark green 墨綠
Product Size 孔內徑約	10cm
Product Size 產品尺寸	325*23*2cm
Product Weight 產品重量	435g
Package Size 包裝尺寸	25.5*20*7cm
Packing Weight 包裝重量	0.545kg

Instructions

- ◆ 將產品取出後從放在膝蓋處從上向下纏繞
- ◆ 然後將兩邊帶子從膝蓋內側繞過來穿過圓孔然後兩邊拉緊固定在床邊扶手或者床沿處即可

注意事項：

- ◆ 此款為棉質產品請遠離火源或高溫環境，以免造成產品損壞，以防影響使用壽命
- ◆ 遠離潮濕環境，以免滋生細菌

Life Nursing

生活護理



Gel Type Anti Pressure Sore Cushion

凝膠型防壓瘡坐墊

Model: NAV

Features:

- Removable cleaning of outer mesh surface
- U-shaped hollow out, breathable fit, no compression on legs, easy to sit for a long time
- Enlarged and widened design makes sitting more comfortable and relieves hip pressure
- Rebound memory cotton, constant temperature gel, relieve fatigue, clean and cool down, full of elasticity
- Applicable to: all kinds of sedentary people
- 外套網面可拆卸清洗
- U型鏤空, 透氣貼合雙腿不壓迫, 輕鬆久坐
- 加大加寬設計, 久坐更舒適, 緩解臀部壓力
- 回彈記憶棉, 恆溫凝膠緩解疲勞, 清理降溫, 彈力十足
- 適用於: 各類久坐人群

Specifications

Product Model 產品型號	NAV
Product Material 產品材質	polyurethane / memory cotton / net cover 聚氨酯+記憶棉+網套
Product Function 產品功能	prevention of pressure sore 防壓瘡
Gel Color 凝膠顏色	white and blue 白藍
Mesh Color 網套顏色	black 黑
Product Size 產品尺寸	45*35*7cm
Product Weight 產品重量	840g
Package Size 包裝尺寸	40*30*20cm
Packing Weight 包裝重量	1.37kg

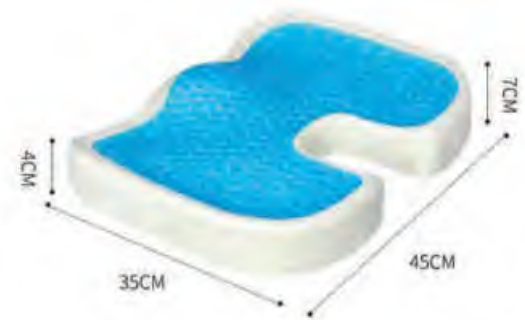

Instructions

- ◆ 將產品取出放置於凳子上或者需要坐的任意位置即可
- ◆ 將外套拉鏈取出即可清洗網套

注意事項:

- ◆ 此款為棉質產品請遠離火源或高溫環境; 以免造成損壞, 影響使用壽命
- ◆ 遠離潮濕環境, 以免滋生細菌
- ◆ 可用濕毛巾或軟佈清洗凝膠墊, (註: 不可用水直接清洗)

Removable Bedsore Washer

拆洗式褥瘡墊圈

Model: NAD

Features:

- Use 3D breathable mesh cloth to prevent stuffiness
- The pure cotton coat is elastic and skin-friendly, with better fixing effect
- Detachable outer cloth cover design, easy to clean and keep clean
- The inner sleeve effectively prevents incontinence and urine from wetting the cotton core
- Suitable for all kinds of wheelchairs and bedridden persons
- Applicable people: long-term bed rest, hemorrhoids, postoperative people, etc.
- 採用3D透氣網眼布, 防止悶熱
- 純棉外套彈性親膚, 固定效果更好
- 可拆式外布套設計, 方便清洗保持清潔
- 內套有效防止失禁尿液打濕棉芯
- 適合各種輪椅坐椅以及臥床者
- 適用人群: 長期臥床、痔瘡、術後人群等

Specifications

Product Model 產品型號	NAD
Product Material 產品材質	pure cotton cloth, waterproof cloth 3d透氣網布、純棉布、防水布
Product Function 產品功能	bedsore prevention 防褥瘡
Specifications 規格	L
Product Color 產品顏色	green 綠色
Product Size 產品尺寸	40*40*9cm
Product Weight 產品重量	0.50kg



Instructions

- ◆ 將墊圈放置於需要的部位下麵即可
- ◆ 清洗時將拉鏈拉開即可取出坐墊, 清洗外套

注意事項:

- ◆ 請遠離火源或高溫環境, 以免造成產品損壞, 防止影響使用壽命
- ◆ 請遠離潮濕環境, 以免滋生細菌
- ◆ 可用清水和洗滌劑清洗, 不要用腐蝕性液體等

Men's Hollow Postoperative Cushion

男款中空術後座墊

Model: NBE

Features:

- Sedentary, not easy to deform, high rebound cushion
- Ergonomic design and hollow design provide sufficient buffer and pressure relief space for the hip
- Strictly selected crystal velvet fabric, breathable and comfortable, sedentary and not sultry, soft and slightly elastic and close to the skin
- Suitable for people who don't use it: office workers, drivers, students and the elderly
- Purpose: travel, office, driving, postoperative recovery, etc
- 久坐不易變形, 高回彈坐墊
- 人體工學設計, 中空設計給予臀部足够的緩衝釋壓空間
- 嚴選水晶絨面料, 透氣舒爽, 久坐不悶熱, 柔軟微彈親膚
- 適合不用人群使用: 上班族、司機、學生、老人
- 用途: 旅行、辦公、駕駛、術後恢復等



Specifications

Product Model 產品型號	NBE
Product Material 產品材質	crystal velvet mesh gauze, polyether polyurethane 水晶絨網紗布.聚醚型聚氨酯
Product Function 產品功能	Ass cushion 屁股坐墊
Product Color 產品顏色	black purple 黑紫
Product Size 產品尺寸	45*36*7cm
Product Weight 產品重量	350g
Package Size 包裝尺寸	47*40*10cm
Packing Weight 包裝重量	0.485kg

Instructions

- ◆ 將墊圈放置於需要的部位下麵即可
- ◆ 清洗時將拉鏈拉開即可取出坐墊, 清洗外套

注意事項:

- ◆ 請遠離火源或高溫環境, 以免造成產品損壞, 防止影響使用壽命
- ◆ 請遠離潮濕環境, 以免滋生細菌
- ◆ 可用清水和洗滌劑清洗, 不要用腐蝕性液體等

Postoperative Nursing Hemorrhoid Pad

術後護理痔瘡墊

Model: NBY

Features:

- Ergonomic curve design, applicable to multiple parts
 - Memory cotton inner core, pressure relief support, specially designed for lying flat and side lying
 - Large hollow design, breathable without pressure
 - Skin friendly comfort, splicing fabric, soft touch, comfortable and breathable
 - Easy to remove and wash, the zipper is smooth and easy to pull
 - Applicable people: long-term bed rest, hemorrhoids, postoperative people, etc.
-
- 符合人體工學的曲線設計，可多部位使用
 - 記憶棉內芯，釋壓支撐，專為平躺、側臥設計
 - 大中空設計，透氣不悶無壓迫
 - 親膚舒適，拼接面料，觸感柔軟，舒適透氣
 - 拆洗方便，拉鏈順滑易拉
 - 適用人群：長期臥床、痔瘡、術後人群等



Specifications

Product Model 產品型號	NBY
Product Material 產品材質	skin friendly elastic fabric, memory cotton 親膚彈性面料、記憶棉
Product Function 產品功能	bedsore prevention 防褥瘡
Product Color 產品顏色	navy blue 藏青色
Product Size 產品尺寸	42*37*9.5cm
Product Weight 產品重量	460g

Instructions

- ◆ 將墊圈放置於需要的部位下即可
- ◆ 清洗時將拉鏈拉開即可取出坐墊，清洗外套

注意事項：

- ◆ 請遠離火源或高溫環境，以免造成產品損壞，防止影響使用壽命
- ◆ 請遠離潮濕環境，以免滋生細菌
- ◆ 可用清水和洗滌劑清洗，不要用腐蝕性液體等

Breathable Bedsore Proof Cushion

透氣防褥瘡坐墊

Model: NAB

Features:

- Breathable and sweat-absorbent cotton cloth, PVC cloth, feel cool and comfortable
- Adopt high-heat compression to accelerate air circulation and distribute 25 inner diameter small holes
- Porous/multiple air chambers, uniform partial pressure
- Seamless seam, compressive and durable
- Applicable to: different groups of people who sit for a long time, such as bed rest, postoperative recovery, pregnant women, etc.
- 透氣吸汗棉布, PVC布, 手感冰爽舒適
- 採用高熱壓縮, 加速空氣流通25個內徑小孔, 均勻分佈
- 多孔/多氣室, 均勻分壓
- 無縫鎖邊, 抗壓耐用
- 適用於: 長期臥床、坐輪椅、腰椎術後恢復、孕婦等久坐久躺不同人群

Specifications

Product Model 產品型號	NAB
Product Material 產品材質	PVC
Product Function 產品功能	bedsore prevention 防褥瘡
Product Bearing 產品承重	100kg
Product Size 產品尺寸	40*40*5cm
Product Weight 產品重量	155g
Package Size 包裝尺寸	15.5*15*5cm
Packing Weight 包裝重量	0.21kg

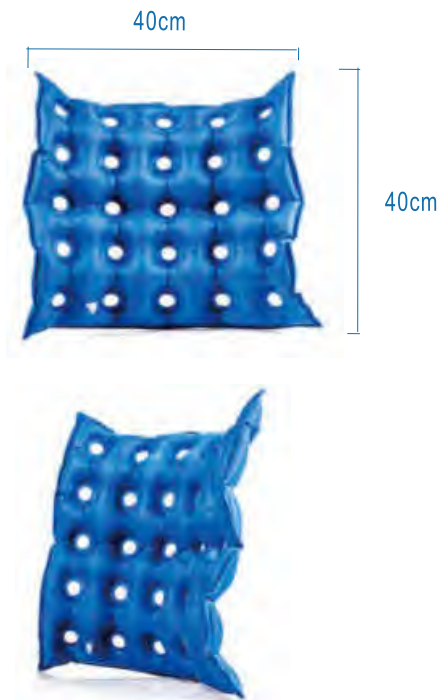

Instructions

- ◆ 將打氣筒插入氣墊的充氣口, 不要充得太足, 微軟, 有彈性
 - ◆ 充氣完畢將氣嘴塞緊, 以免漏氣
 - ◆ 產品受到擠壓會有輕微放氣, 需3-4天補打一次氣
- 放氣步驟
- ◆ 將密封圈輕輕往外拔出, 突出密封圈
 - ◆ 捏緊氣嘴, 聽到“吡吡”聲即可放氣

注意事項:

- ◆ 本產品充氣時一定不要充太足, 以免發生意外
- ◆ 本品承重應不超過100KG
- ◆ 用充氣泵充氣時, 要注意壓力控制, 不能超過最大壓力
- ◆ 在使用過程中, 如果發現有漏氣現象, 請停止使用
- ◆ 避免尖銳物品刺破墊體, 若不小心弄破, 嚴禁使用
- ◆ 清洗氣墊直接用中性洗滌劑清洗表面、曬乾
- ◆ 使用後注意保持清潔, 然後放在通風、乾燥處, 注意防潮
- ◆ 請不要改造本品或超出說明書的適用範圍, 否則會造成嚴重傷害

Double Sided Curve Butterfly Pillow

雙面曲線蝴蝶枕

Model: NBZ

Features:

- Soft support without pressure, pressure release, comfortable fit
- Air layer fabric, jacquard colored cotton, dustproof, bacteriostatic and skin friendly; Protect pillow core from bacterial contamination
- Surrounding support points can change bad sleeping habits and reject cervical vertebra reverse arch if used for a long time
- Hidden pull head, more convenient to remove and wash
- 柔軟支撐無壓迫, 釋放壓力, 舒適貼合
- 空氣層面料, 提花彩紋棉, 防塵抑菌、親膚; 保護枕芯不易被細菌污染
- 環繞式支撐點, 長期使用能改變不良睡姿習慣, 拒絕頸椎反弓
- 隱藏式拉頭, 拆洗更方便

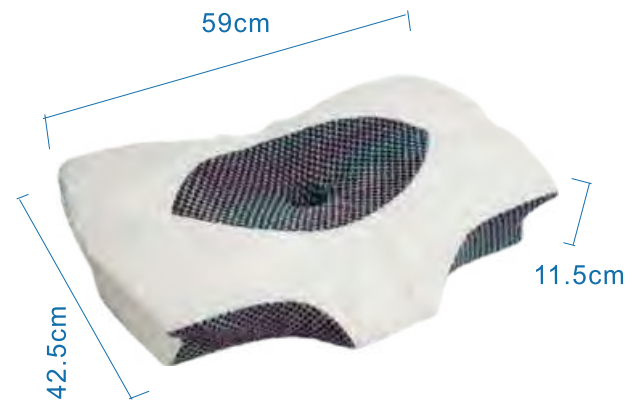

Specifications

Product Model 產品型號	NBZ
Product Material 產品材質	memory cotton, jacquard colored cotton 記憶棉, 提花彩紋棉
Product Function 產品功能	waist soothing 腰部舒緩
Product Size 產品尺寸	59*42.5*11.5cm
Product Weight 產品重量	1340g
Package Size 包裝尺寸	30*26.5*24.5cm
Packing Weight 包裝重量	1.76kg

Instructions

- ◆ 將產品取出放置於床上躺上面即可

注意事項:

- ◆ 枕芯不可水洗!
- ◆ 請遠離火源或高溫環境。以免造成產品損壞, 以防影響使用壽命
- ◆ 遠離潮濕環境, 以免滋生細菌
- ◆ 外套可以直接水洗

Traditional Chinese Medicine Combination Pillow

中藥頸椎組合枕(圓枕+方枕)

Model: NDA

Features:

- Take natural fresh herbs, care for cervical vertebra, and sleep deeply
- 12 kinds of traditional Chinese medicine ingredients can help you sleep soundly all night
- Easy to disassemble strap design, the zipper of the inner pillow case is dense and effective to prevent leakage

- 取材大自然清新草本, 呵護頸椎, 深度睡眠
- 12種中藥成分, 伴您健康熟睡一整晚
- 易拆卸綁帶設計, 內枕套拉鏈密實有效防漏

Specifications

Product Model 產品型號	NDA
Product Material 產品材質	brocade+linen 錦緞+亞麻
Product Function 產品功能	chinese medicine helps sleep 中藥助眠
Product Size 產品尺寸	column pillow 圓柱枕:50*9*9cm square pillow 方枕:50*30cm
Product Weight 產品重量	1620g
Package Size 包裝尺寸	48*40*15cm
Packing Weight 包裝重量	1.76kg



Instructions

- ◆ 將產品取出放置於床上躺上面即可

注意事項:

- ◆ 枕芯不可水洗!
- ◆ 請遠離火源或高溫環境。以免造成產品損壞, 以防影響使用壽命
- ◆ 遠離潮濕環境, 以免滋生細菌
- ◆ 外套可以直接水洗

Memory Cotton Waist Cushion

記憶棉護腰靠墊

Model: NBF

Features:

- The size of the backrest is enlarged, and the saddle radian is designed to fit the S curve of the spine, making the waist more comfortable and decompression
- The design of rear elastic band is adopted to freely control the position of lumbar support and firmly fix it
- It can be disassembled and cleaned independently, which is convenient to take care of
- Suitable for: office, sedentary, postoperative backrest and other people
- 靠面加大尺寸，馬鞍弧度設計，貼合脊椎S曲線，腰部更舒適，更減壓
- 採用後置鬆緊帶的設計，自由控制腰靠位置，牢牢固定
- 可獨立拆卸清洗，方便打理
- 適用於：辦公室、久坐、術後靠背等人群

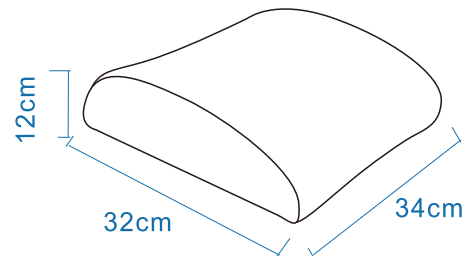

Specifications

Product Model 產品型號	NBF
Product Material 產品材質	Memory cotton, polyester 記憶棉, 聚酯纖維
Product Function 產品功能	waist soothing 腰部舒緩
Product Color 產品顏色	purple 紫色
Product Size 產品尺寸	34*32*12cm
Product Weight 產品重量	370g
Package Size 包裝尺寸	47*40*10cm
Packing Weight 包裝重量	0.49kg

Instructions

- ◆ 將產品取出套在凳子上或者需要坐靠的任意位置即可
- ◆ 將外套拉鏈取出即可清洗網套

注意事項:

- ◆ 請遠離火源或高溫環境,以免造成產品損壞,防止影響使用壽命
- ◆ 請遠離潮濕環境,以免滋生細菌
- ◆ 可用清水和洗滌劑清洗,不要用腐蝕性液體等

Push On Inflatable Lumbar Pillow

按壓式充氣腰枕

Model: NDK

Features:

- The concave design in the middle keeps the waist in a natural and comfortable state
 - Press to inflate, say goodbye to the embarrassment of mouth blowing, designed for comfortable travel
 - Foldable storage, convenient to carry, no space
- 中部凹型設計, 使腰部保持自然舒適狀態
 - 按壓充氣, 告別嘴吹尷尬, 為舒適出行而設計
 - 可折疊收納, 攜帶方便, 不占空間



Specifications

Product Model 產品型號	NDK
Product Material 產品材質	polyester+TPU coating 聚酯纖維+TPU塗層
Product Function 產品功能	support the waist 支撐腰部
Color 顏色	navy blue 藏青色
Product Size 產品尺寸	43*32*12cm
Product Weight 產品重量	129g
Package Size 包裝尺寸	15*15*5cm
Packing Weight 包裝重量	0.19kg

Instructions

◆ 蓋上後面充氣閥, 雙手重複按壓充氣閥(氣閥要打開), 充氣完成。

注意事項:

- ◆ 請勿使用金屬清潔球等尖銳物品進行清洗;
- ◆ 使用後請及時洗淨晾乾;
- ◆ 請勿長期置於高溫場所, 以免變形;
- ◆ 請勿接觸明火及腐蝕性液體。

Portable Inflatable U-shaped Pillow

便攜充氣U型枕

Model: NDI

Features:

- Neck protection design, relieve the pressure of cervical vertebra, and provide no sense of support
- Press the inflation valve gently to complete inflation,
- The concealed air outlet valve can be deflated with a slight pull
- Composite adhesive sealing makes the joint more firm and not easy to leak

- 護頸設計, 緩解頸椎壓力, 無感支撐
- 按壓式充氣閥, 輕輕按壓, 即可完成充氣,
- 隱藏式出氣閥, 輕輕一拉, 即可完成放氣
- 複合壓膠封邊, 使接縫處更牢固不易漏氣



Specifications

Product Model 產品型號	NDI
Product Material 產品材質	PVC flocking PVC植絨
Product Function 產品功能	support neck 支撐頸部
Color 顏色	malachite blue 孔雀藍
Product Size 產品尺寸	34*24*11cm
Product Weight 產品重量	85g
Package Size 包裝尺寸	15*15*5cm
Packing Weight 包裝重量	0.14kg

Instructions

◆ 蓋上後面充氣閥, 雙手重複按壓充氣閥(氣閥要打開), 充氣完成。

注意事項:

- ◆ 請勿使用金屬清潔球等尖銳物品進行清洗;
- ◆ 使用後請及時洗淨晾乾;
- ◆ 請勿長期置於高溫場所, 以免變形;
- ◆ 請勿接觸明火及腐蝕性液體。

Inflatable U-shaped Pillow With Cap

按壓充氣帶帽U型枕

Model: NDM

Features:

- Small storage, no space
- The inner liner is made of high elastic and cold resistant PVC, which is soft, durable and not easy to leak
- Shading hood design, blocking light and air conditioning
- Rotary air valve design, faster inflation/deflation speed

- 收納小巧, 不占地方
- 內膽選用高彈耐寒PVC材質, 柔軟耐用、不易漏氣
- 遮光連帽設計, 遮擋光線, 阻擋空調風
- 旋轉氣閥設計, 充氣/放氣速度更快



Specifications

Product Model 產品型號	NDM
Product Material 產品材質	cool cloth+PVC 冰爽布+PVC
Product Function 產品功能	support neck 支撐頸部
Color 顏色	grey 灰色
Product Size 產品尺寸	31*31*11cm
Product Weight 產品重量	240g
Package Size 包裝尺寸	20*10*10cm
Packing Weight 包裝重量	0.3kg

Instructions

- ◆ 將旋轉氣閥擰向OFF, 按壓充氣, 旋轉氣閥擰向ON放氣
- ◆ 洗滌方式: 內膽與外套可分開拆洗, 外套可機洗手洗內膽不可清洗 (可用布擦拭乾淨)

注意事項:

- ◆ 請勿使用金屬清潔球等尖銳物品進行清洗;
- ◆ 使用後請及時洗淨晾乾;
- ◆ 請勿長期置於高溫場所, 以免變形;
- ◆ 請勿接觸明火及腐蝕性液體。

Inflatable Prone Pillow

充氣趴睡抱枕

Model: NDJ

Features:

- High quality flocking fabric, soft and skin friendly, healthy and environment-friendly
- Hot pressing seamless sealing technology, good and firm sealing
- Double air holes, quick inflation and deflation, simple and portable
- Hand digging design, release your hands and relieve fatigue
- Hollow breathing area, breathable and not stuffy
- 優質植絨面料, 柔軟親膚, 健康環保
- 熱壓無縫密封技術, 密封性好又牢固
- 雙重氣孔, 快速充氣放氣, 簡約便攜
- 挖手設計, 釋放雙手, 緩解旅途疲勞
- 中空呼吸區, 透氣不悶熱

Specifications

Product Model 產品型號	NDJ
Product Material 產品材質	PVC flocking PVC植絨
Product Function 產品功能	support head 支撐頭部
Color 顏色	grey 灰色
Product Size 產品尺寸	30*30*50cm
Product Weight 產品重量	273g
Package Size 包裝尺寸	25*20*7cm
Packing Weight 包裝重量	0.44kg



Instructions

- ◆ 將打氣筒插入氣墊的充氣口, 打氣時氣不要充得太足, 微軟, 有彈性
- ◆ 充氣完畢將氣嘴塞緊, 以免漏氣

注意事項:

- ◆ 請勿使用金屬清潔球等尖銳物品進行清洗;
- ◆ 使用後請及時洗淨晾乾;
- ◆ 請勿長期置於高溫場所, 以免變形;
- ◆ 請勿接觸明火及腐蝕性液體。

Press The Inflatable Sleeping Pillow

按壓充氣臥睡抱枕

Model: NDP

Features:

- High quality flocking fabric, soft and skin friendly, healthy and environment-friendly
- Hot pressing seamless sealing technology, good and firm sealing
- Double air holes, quick inflation and deflation, simple and portable
- Hand digging design, release your hands and relieve fatigue
- Hollow breathing area, breathable and not stuffy
- 優質植絨面料, 柔軟親膚, 健康環保
- 熱壓無縫密封技術, 密封性好又牢固
- 雙重氣孔, 快速充氣放氣, 簡約便攜
- 挖手設計, 釋放雙手, 緩解旅途疲勞
- 中空呼吸區, 透氣不悶熱



Specifications

Product Model 產品型號	NDP
Product Material 產品材質	Flocking+TPU composite cloth 植絨+TPU複合布
Product Function 產品功能	support head 支撐頭部
Color 顏色	grey 灰色
Product Size 產品尺寸	26*32*37cm
Product Weight 產品重量	350g
Package Size 包裝尺寸	21.5*11*14cm
Packing Weight 包裝重量	0.42kg

Instructions

◆將旋轉氣閥擰向OFF, 按壓充氣, 旋轉氣閥擰向ON放氣。

注意事項:

- ◆請勿使用金屬清潔球等尖銳物品進行清洗;
- ◆使用後請及時洗淨晾乾;
- ◆請勿長期置於高溫場所, 以免變形;
- ◆請勿接觸明火及腐蝕性液體。
- ◆溫馨提示: 髒了可用濕布擦拭, 無需清洗!

Children's Sleeping Pillow

兒童趴睡枕 (配收納袋)

Model: NDN

Features:

- The middle hole of the face is designed to fit the face contour and improve the smoothness of breathing
 - Arm jack design allows the arm to stretch freely
 - Plain cloth is comfortable to the skin, warm memory cotton pillow core, normal rebound at minus 15 °, soft touch
 - Zipper design, easy to remove cloth cover for cleaning
 - Cross storage bag buckle, no space after storage
-
- 面部中孔設計, 貼合臉部輪廓, 提升呼吸的順暢度
 - 手臂插孔設計, 手臂伸縮自如
 - 平紋布親膚舒適, 溫感記憶棉枕芯, 零下15°正常回彈, 柔軟觸感
 - 拉鏈設計, 方便拆下布套清洗
 - 十字收納袋卡扣, 收納之後不占空間

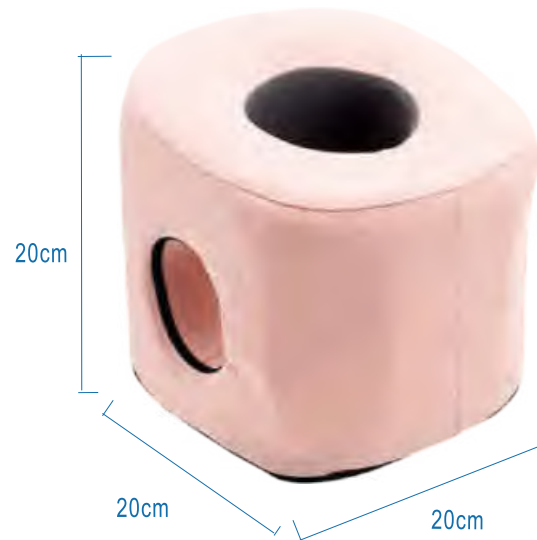

Specifications

Product Model 產品型號	NDN
Product Material 產品材質	pull frame plain cloth+memory cotton 拉架平紋布+記憶棉
Product Function 產品功能	support head 支撐頭部
Color 顏色	coral pink 珊瑚粉
Product Size 產品尺寸	20*20*20cm
Product Weight 產品重量	340g
Package Size 包裝尺寸	21.5*11*14cm
Packing Weight 包裝重量	0.49kg

Instructions

- ◆ 洗滌方式: 布套可拆出清洗, 建議手洗, 布套不易變形
- ◆ 收納: 將十字收納卡扣平鋪好, 將產品放在十字卡扣中間, 直接將兩邊十字卡扣扣好即可

注意事項:

- ◆ 請勿使用金屬清潔球等尖銳物品進行清洗;
- ◆ 使用後請及時洗淨晾乾;
- ◆ 請勿長期置於高溫場所, 以免變形;
- ◆ 請勿接觸明火及腐蝕性液體。

Inflatable Single Floor Mat

充氣單層腳墊

Model: NDO

Features:

- Hot pressing process, more load-bearing
- High-quality flocking fabric, comfortable and soft, sweat-absorbing and breathable
- Convenient inflation, simple and compact storage

- 熱壓工藝, 承重更強
- 優質植絨面料, 親膚舒適柔, 吸汗透氣
- 充氣方便, 收納簡單小巧

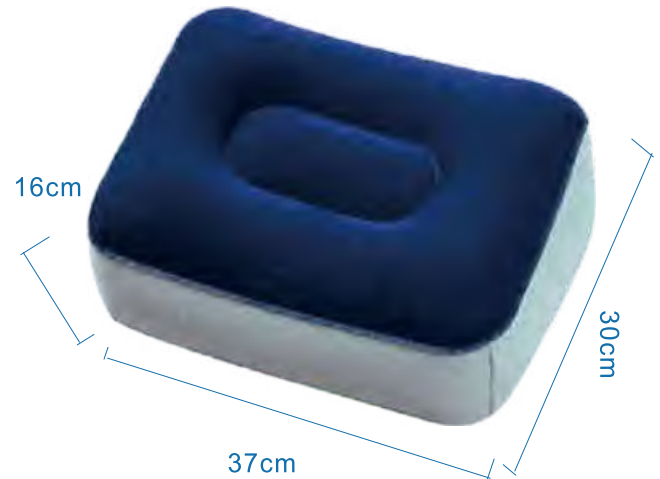

Specifications

Product Model 產品型號	NDO
Product Material 產品材質	PVC flocking PVC植絨
Product Function 產品功能	support the foot 支撐足部
Color 顏色	blue grey 藍灰
Product Size 產品尺寸	16*30*37cm
Product Weight 產品重量	97g
Package Size 包裝尺寸	12*12*5cm
Packing Weight 包裝重量	0.13kg

Instructions

- ◆ 充氣至90%關閉第一段蓋子, 打開蓋子充氣至所需硬度。
- ◆ 拔出蓋子即可洩氣。

注意事項:

- ◆ 請勿使用金屬清潔球等尖銳物品進行清洗;
- ◆ 使用後請及時洗淨晾乾;
- ◆ 請勿長期置於高溫場所, 以免變形;
- ◆ 請勿接觸明火及腐蝕性液體。

Fixed Bedside Armrest / Bed Guard - Wake Up Booster

固定式床邊扶手/床護欄-起床助力器

Model: WBF

Features:

- The thick mattress can be directly placed on the bottom of the mattress for easy operation
- Butterfly triangle design, solid C-type bolt, fixed without shaking
- High quality high carbon steel main material, tool free installation, convenient assembly and disassembly
- The armrest can be adjusted (50 ~ 54cm) to meet the requirements of different thickness mattresses
- Applicable crowd: the elderly, the disabled, the injured, the disabled, pregnant women, etc
- 厚床褥可直接置壓於床褥底部使用, 操作簡單
- 蝶形三角區設計, 結實C型插銷固定不搖晃
- 優質高碳鋼主材, 免工具安裝, 裝拆方便快捷
- PU泡棉防滑扶手, 柔軟舒適更安全
- 扶手可調節(50~54CM)滿足不同厚度床墊的要求
- 適用人群: 老年人、殘疾人、受傷人士、行動不便者、孕婦等

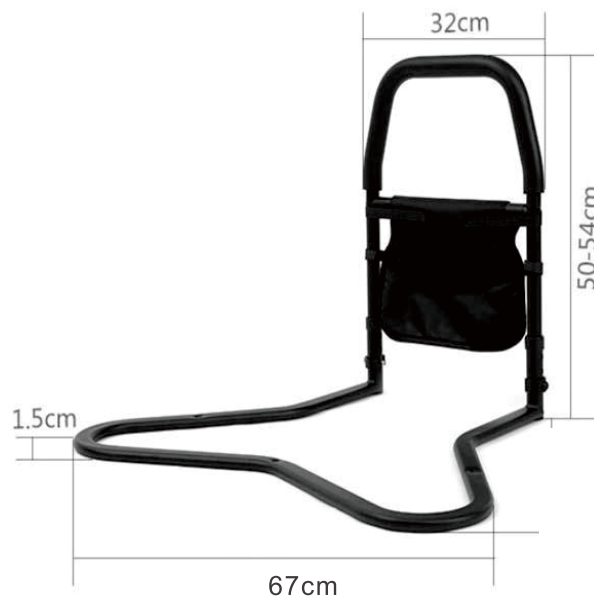

Specifications

Product Model 產品型號	WBF
Material 材質	carbon steel + PU 碳鋼+PU
Product Function 產品功能	wake up booster 起床助力
Color 顏色	black 黑色
Product Bearing 產品承重	136kg
Product Size 產品尺寸	67*55*1.5cm
Product Weight 產品重量	2.40kg
Package Size 包裝尺寸	68*57*12.5cm
Packing Weight 包裝重量	3.50kg

Instructions

- ◆ 打開包裝取出所有配件
- ◆ 扶手對準底座兩管口插入
- ◆ 對準孔位, 左右管各插入一個C型插銷固定
- ◆ 抬起床墊, 放入床墊壓緊即安裝完成

注意事項:

- ◆ 使用前請檢查每個點的卡扣有無問題, 確認全部卡到位之後方可安心使用

Household Atomizer For Children And Adults

兒童成人家用霧化器

Model: NBB

Features:

- Handheld network, small and light, easy to carry out, anytime, anywhere, easy to atomize
 - The fog is large, the atomized particles are fine, and the particles are about $\leq 3.7 \mu\text{m}$
 - Microporous spray tablet, atomization speed $\geq 0.25\text{ml}/\text{min}$
 - The residue of liquid medicine is $\leq 0.5\text{ml}$, which is economical to use
 - The mask is comfortable, skin friendly and environment-friendly. The mask is made of PP (polypropylene) without DEHP (plasticizer / plasticizer)
- 手持網路式, 小巧輕便, 外出方便攜帶, 隨時隨地, 輕鬆霧化
 - 出霧大, 霧化顆粒細膩, 顆粒約 $\leq 3.7\mu\text{m}$, 藥物吸收充分
 - 微孔噴霧片, 霧化速度 $\geq 0.25\text{ml}/\text{min}$
 - 藥液殘留 $\leq 0.5\text{ml}$, 使用經濟
 - 面罩舒適, 親膚環保, 面罩採用PP(聚丙烯)為主體的材質, 不含DEHP(即增塑劑/塑化劑)



Specifications

Product Model 產品型號	NBB
Product Material 產品材質	ABS+PP
Product Function 產品功能	medicament atomization 藥劑霧化
Medicine cup capacity 藥杯容量	10mL
Oscillation frequency 振蕩頻率	100kHz+10%
Working noise 工作噪音	$\leq 50\text{dB}$
Atomized particles 霧化顆粒	3.7nm
Atomization speed 霧化速度	$\geq 0.25\text{ml}/\text{min}$
Waterproof grade 防水等級	IP22
Maximum water temperature i 藥杯內最大水溫	$\leq 50^\circ\text{C}$
Automatic shutdown 自動關機	Work for 20 minutes 工作20分鐘
Product Size 產品尺寸	10.5*7*4cm
Product Weight 產品重量	89g

Instructions



1. 裝入電池或接上USB線
2. 在藥杯內注入藥劑
3. 裝上霧化面罩或吸管
4. 按下開關開始霧化

注意事項:

- ◆ 請使用前認真閱讀產品說明書
- ◆ 請遠離火源及潮濕環境, 避免陽光暴曬
- ◆ 本產品可以兩種電源方式使用, 用電池時電量用完後請及時更換, 以免影響使用
- ◆ 每次使用完請及時清洗藥杯
- ◆ 內裡面罩請根據成人和小孩使用

Leak Proof And Waterproof Dining Apron

防漏防水用餐圍裙

Model: NBH

Features:

- Ultra light fabric, soft and comfortable
- DuPont Teflon coating, waterproof, oil proof, easy to clean
- Buckle design at the neckline, which can be adjusted at will
- Avoid spilling vegetable soup during meals

- 超輕面料, 柔軟舒適
- 美國杜邦特氟龍塗層, 防水, 防油污, 易清洗
- 領口粘扣設計, 可隨意調節
- 可避免用餐時菜湯外灑

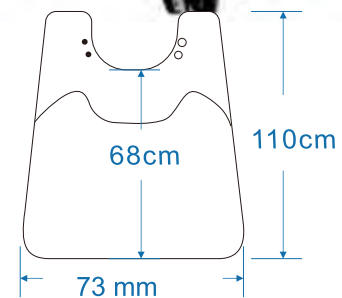

Specifications

Product Model 產品型號	NBH
Product Material 產品材質	polyester fiber, teflon coating 聚酯纖維, 特氟龍塗層
Product Function 產品功能	prevent spilling contaminated clothes during meals 防止用餐時外灑污染衣物
Product Color 產品顏色	black purple blue pattern 藍色花紋
Product Size 產品尺寸	73*110*68cm
Product Weight 產品重量	100g
Package Size 包裝尺寸	15.5*15*5cm
Packing Weight 包裝重量	0.13kg

Instructions

◆ 使用時將產品取出套在脖子處, 根據自身需求的大小來粘貼粘扣即可

注意事項:

◆ 此款為護理物品, 請遠離火源或高溫環境, 以免造成產品損壞, 以防影響使用壽命

◆ 遠離潮濕環境, 以免滋生細菌

◆ 使用後可以直接水洗也可以將污糟處擦拭掉即可

Foldable No Bend Shampoo Basin

可折疊免彎腰洗發盆

Model: NAH

Features:

- The neck circumference is adjustable in 6 grades, and the size can be adjusted according to personal needs
- Front belt and back buckle design, pregnant women can easily wear it
- It is light and does not occupy space. It can be hung and easy to carry
- Easy drainage: there is no ponding inside the product, and the drainage pipe is directly connected to the floor drain
- Applicable groups: children, pregnant women, the elderly and inconvenient groups
- 頸圍6檔鬆緊可調, 可根據個人需求調節大小
- 前帶後扣式設計, 孕婦也能輕鬆配帶
- 輕薄不占空間, 可塞夾角、可懸掛, 方便攜帶
- 輕鬆排水: 肩頸無壓力產品內部不積水, 排水管直接連接地漏, 排水方便
- 適用人群: 兒童、孕婦、老人及不方便人群設計



Specifications

Product Model 產品型號	NAH
Product Material 產品材質	TPE+PP
Product Function 產品功能	assist in shampoo 協助行動不便人士洗頭
Expanded Size 展開尺寸	48*43*31cm
Folding Size 折疊尺寸	48*43*8cm
Water Pipe Size 水管尺寸	60-150cm
Product Weight 產品重量	637g
Package Size 包裝尺寸	52*45*8.5cm
Packing Weight 包裝重量	1.45kg

Instructions

- ◆ 將產品取出輕按展開洗發盆, 將固定帶連接在洗發盆上面連接處,
- ◆ 固定好後再將洗發盆固定於後脖處, 將固定帶固定於腰腹處
- ◆ 然後將頸圍卡扣按照自己脖子大小固定住
- ◆ 再將洗發盆下方的排水管安裝好
- ◆ 將毛巾放置於後脖處墊好, 以防磨傷脖子
- ◆ 可根據自身需要來決定是否佩戴防水耳塞

注意事項:

- ◆ 此款為塑膠製品請遠離火源或高溫環境, 以免造成產品損壞, 以防影響使用壽命
- ◆ 此產品為可折疊款, 易收納

Foldable Shampoo Basin

可折疊洗發盆

Model: NBV

Features:

- When using, the soft glue is close to the skin, so there will be no water leakage when washing
- There is no water in the water pocket, the drain pipe can drain directly, and there is no pressure on the shoulder
- Lightweight, space-efficient, hanging
- Applicable to: children, pregnant women, the elderly and inconvenient people

- 使用時軟膠緊貼皮膚,在沖洗時就不會出現漏水
- 蓄水兜內不積水,排水管可以直接排水,肩膀無壓力
- 輕薄不占空間,可懸掛
- 適用人群:兒童、孕婦、老人及不方便人群設計

Specifications

Product Model 產品型號	NBV
Product Material 產品材質	TPE
Product Function 產品功能	assist in shampoo 協助行動不便人士洗頭
Expanded Size 展開尺寸	54.5*40.1*4cm
Folding Size 折疊尺寸	54.5*40.1*26.2cm
Water Pipe Size 水管尺寸	MAX150cm 最長150cm
Product Weight 產品重量	600g
Package Size 包裝尺寸	47.5*41.5*5.5cm
Packing Weight 包裝重量	940g



Instructions

- ◆ 使用時根據使用者的頸圍調節大小到合適的位置即可

注意事項:

- ◆ 此款為護理物品,請遠離火源或高溫環境。以免造成產品損壞,以防影響使用壽命
- ◆ 遠離潮濕環境,以免滋生細菌
- ◆ 使用後可以直接水洗也可以將汗槽處擦拭掉即可

Horizontal washbasin

平躺式洗頭盆

Model: NDE

Features:

- Ergonomic radian design, comfortable and comfortable
It fits the neck radian and is not easy to enter water
- The strong basin is not easy to break and bears strong load
- External hose drainage, easy drainage by pulling out the water plug
- Applicable to: children, pregnant women, the elderly and inconvenient people

- 人體工學弧度設計, 舒適不咯脖子
- 貼合頸部弧度, 不易進水
- 結實盆體不易破, 強力承重
- 外接軟管排水, 抽出水塞即可輕鬆排水
- 適用人群: 兒童、孕婦、老人及不方便人群設計

Specifications

Product Model 產品型號	NDE
Product Material 產品材質	PET
Product Function 產品功能	assist in shampoo 協助行動不便人士洗頭
Expanded Size 展開尺寸	48*43*31cm
Color 顏色	transparent blue 透藍
Product Size 產品尺寸	48*35*14cm
Product Weight 產品重量	1240g
Package Size 包裝尺寸	48*40*15cm
Packing Weight 包裝重量	1.5kg

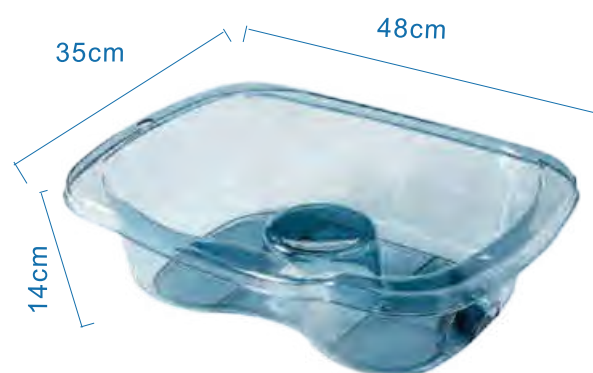

Instructions

注意事項:

- ◆ 請勿使用金屬清潔球等尖銳物品進行清洗;
- ◆ 使用後請及時洗淨晾乾;
- ◆ 請勿長期置於高溫場所, 以免變形;
- ◆ 請勿接觸明火及腐蝕性液體。

Silicone Waterproof Care Bib

矽膠防水護理圍兜

Model: NBU

Features:

- Lightweight wear, widened shoulder strap to disperse pressure, and no sense of pressure when worn for a long time
- Strong pull without deformation, soft and foldable, easy to store and carry
- Wearing 6-gear adjustable, flexible
- Water and oil resistant, can be washed directly, easy to clean
- Applicable to the elderly and children who need care

- 穿戴輕盈, 加寬肩帶分散壓力, 長時間佩戴無壓力感
- 強力拉扯不變形, 柔軟可疊, 易收納攜帶
- 佩戴6檔可調節, 鬆緊自如
- 防水防油, 可直接水洗, 易清洗潔淨
- 適用於老人小孩等需照料人群



Specifications

Product Model 產品型號	NBU
Product Material 產品材質	food grade silicone 食品級矽膠
Product Function 產品功能	waterproof and dirt-proof 防水防髒
Product Color 產品顏色	blue 藍色
Product Size 產品尺寸	43*30*2cm
Product Weight 產品重量	170g
Package Size 包裝尺寸	15.5*15*5cm
Packing Weight 包裝重量	220g

Instructions

- ◆ 將產品先用水清洗, 晾乾後即可使用
- ◆ 使用時根據使用者的頸圍調節大小到合適的位置即可

注意事項:

- ◆ 此款為護理物品, 請遠離火源或高溫環境。以免造成產品損壞, 以防影響使用壽命
- ◆ 遠離潮濕環境, 以免滋生細菌
- ◆ 使用後可以直接水洗也可以將汗糟處擦拭掉即可

Toilet Flush Bidet

馬桶用沖洗坐浴盆

Model: NDD

Features:

- Fit hips, humanized concave curve, comfortable sitting posture
- High temperature resistance and stability, no deformation when hot water is poured
- Integral molding, smooth surface, easy to clean, not easy to breed bacteria
- Widening design of the basin edge, which fits the toilet and is stable
- The front bulge is easy to lift, and the rear overflow port is easy to pour water
- Equipped with washer and fumigation cover plate
- 貼合臀部, 人性化內凹曲線, 坐姿舒適
- 耐高溫穩定性好, 倒入熱水也不變形
- 一體成型, 表面光滑易清洗, 不易滋生細菌
- 盆邊加寬設計, 貼合馬桶使用穩固
- 前置凸起易提起, 後置溢水口易倒水
- 配有沖洗器和薰蒸蓋板

Specifications

Product Model 產品型號	NDD
Product Material 產品材質	PP
Product Function 產品功能	convenient for cleaning buttocks 方便清洗臀部
Color 顏色	blue 藍色
Product Size 產品尺寸	39*39*12cm
Product Weight 產品重量	420g
Package Size 包裝尺寸	40*40*25cm
Packing Weight 包裝重量	0.52kg



Instructions

◆將沖洗管穿過開孔, 將沖洗嘴安裝到管子上, 將吸盤放到盆中央, 安裝完成

注意事項:

- ◆請勿使用金屬清潔球等尖銳物品進行清洗;
- ◆使用後請及時洗淨晾乾;
- ◆請勿長期置於高溫場所, 以免變形;
- ◆請勿接觸明火及腐蝕性液體。

Hand Wound Shower Waterproof Cover

手部創傷沐浴防水套

Model: NBA

Features:

- The material has strong crushing resistance and is easy to clean
- It can protect the affected area from serious deterioration in case of water
- Applicable to: daily wound care in case of hand trauma, etc. it can also be used as outdoor wound protection in rainy days. The product can be used repeatedly
- 材料防碎性強, 易清洗
- 可保護患處遇水惡化嚴重
- 主要用於: 人體手部有創傷等情況下的傷口日常護理, 也可以作雨天戶外傷口的防護, 產品可反復使用

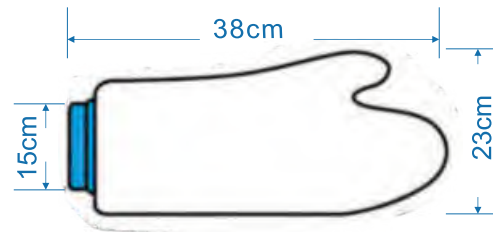

Specifications

Product Model 產品型號	NBA
Product Material 產品材質	PVC silica gel PVC 矽膠
Product Function 產品功能	hand waterproof protection 手部防水保護
Product Size 產品尺寸	15*38*23cm
Product Weight 產品重量	108g
Package Size 包裝尺寸	16*19*3cm
Packing Weight 包裝重量	0.14kg

Instructions

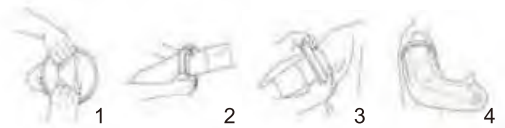

1. 沐浴前, 由家人協助將其護理套的彈性密封圈子撐大
2. 患者緩慢地將患肢插入套內, 盡力避免觸碰到患處
3. 當患處完全入內, 讓彈性密封圈自然復位, 並同時調整彈性密封圈以便密封圈緊密
4. 準備完成即可進行沐浴

注意事項:

- ◆ 沐浴時間不宜超過20分鐘
- ◆ 沐浴後護理套內外均需用幹布擦乾後收藏, 禁止用吹風機吹幹
- ◆ 產品如有破損, 禁止使用

Arm Wound Shower Waterproof Cover

手臂創傷沐浴防水套

Model: NBN

Features:

- The material has strong crushing resistance and is easy to clean
- It can protect the affected area from serious deterioration in case of water
- Applicable to: daily wound care in case of hand trauma, etc. it can also be used as outdoor wound protection in rainy days. The product can be used repeatedly
- 材料防碎性強, 易清洗
- 可保護患處遇水惡化嚴重
- 主要用於: 人體手部有創傷等情況下的傷口日常護理, 也可以作雨天戶外傷口的防護, 產品可反復使用



Specifications

Product Model 產品型號	NBN
Product Material 產品材質	PVC silica gel PVC 矽膠
Product Function 產品功能	hand waterproof protection 手部防水保護
Product Size 產品尺寸	58*26*15cm / 55*24*15cm
Product Weight 產品重量	130g / 125g
Package Size 包裝尺寸	16*19*3cm
Packing Weight 包裝重量	0.163kg / 0.154kg

Instructions

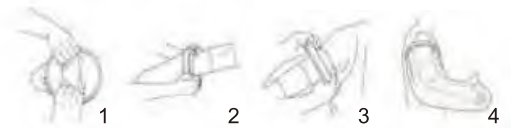

1. 沐浴前, 由家人協助將其護理套的彈性密封圈子撐大
2. 患者緩慢地將患肢插入套內, 盡力避免觸碰到患處
3. 當患處完全入內, 讓彈性密封圈自然復位, 並同時調整彈性密封圈以便密封圈緊密
4. 準備完成即可進行沐浴

注意事項:

- ◆ 沐浴時間不宜超過20分鐘
- ◆ 沐浴後護理套內外均需用幹布擦乾後收藏, 禁止用吹風機吹幹
- ◆ 產品如有破損, 禁止使用

Foot Trauma Bath Waterproof Cover

腳部創傷沐浴防水套

Model: NBO

Features:

- The material has strong crushing resistance and is easy to clean
- It can protect the affected area from serious deterioration in case of water
- Applicable to: daily wound care in case of foot trauma, etc. it can also be used as outdoor wound protection in rainy days. The product can be used repeatedly
- 材料防碎性強, 易清洗
- 可保護患處遇水惡化嚴重
- 主要用於: 腳部有創傷等情況下的傷口日常護理, 也可以作雨天戶外傷口的防護, 產品可反復使用

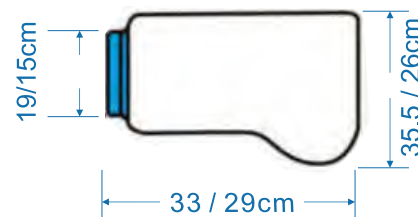

Specifications

Product Model 產品型號	NBO
Product Material 產品材質	PVC silica gel PVC 矽膠
Product Function 產品功能	waterproof protection for feet 腳部防水保護
Product Size 產品尺寸	35.5*19*33cm / 29*26*15cm
Product Weight 產品重量	140g/108g
Package Size 包裝尺寸	23*20*3cm / 16*19*3 cm
Packing Weight 包裝重量	0.193kg / 0.143kg

Instructions

- ◆ 沐浴前, 由家人協助將其護理套的彈性密封圈子撐大
- ◆ 患者緩慢地將患肢插入套內, 盡力避免觸碰到患處
- ◆ 當患處完全入內, 讓彈性密封圈自然復位, 並同時調整彈性密封圈以便密封圈緊密
- ◆ 準備完成即可進行沐浴

注意事項:

- ◆ 沐浴時間不宜超過20分鐘
- ◆ 沐浴後護理套內外均需用幹布擦乾後收藏, 禁止用吹風機吹幹
- ◆ 產品如有破損, 禁止使用

Leg Wound Bath Waterproof Cover

腿部創傷沐浴防水套

Model: NBP

Features:

- The material has strong crushing resistance and is easy to clean
- It can protect the affected area from serious deterioration in case of water
- Applicable to: daily wound care in case of leg trauma, or outdoor wound protection in rainy days. The product can be used repeatedly
- 材料防碎性強, 易清洗
- 可保護患處遇水惡化嚴重
- 主要用於: 腿部有創傷等情況下的傷口日常護理, 也可以作雨天戶外傷口的防護, 產品可反復使用



Specifications

Product Model 產品型號	NBP
Product Material 產品材質	PVC silica gel PVC 矽膠
Product Function 產品功能	waterproof protection for legs and feet 腿部、腳部防水保護
Product Size 產品尺寸	63*42*19cm / 46*35*19cm
Product Weight 產品重量	198g / 178g
Package Size 包裝尺寸	23*20*3cm
Packing Weight 包裝重量	0.247kg / 0.227kg

Instructions

- ◆ 沐浴前, 由家人協助將其護理套的彈性密封圈子撐大
- ◆ 患者緩慢地將患肢插入套內, 盡力避免觸碰到患處
- ◆ 當患處完全入內, 讓彈性密封圈自然復位, 並同時調整彈性密封圈以便密封圈緊密
- ◆ 準備完成即可進行沐浴

注意事項:

- ◆ 沐浴時間不宜超過20分鐘
- ◆ 沐浴後護理套內外均需用幹布擦乾後收藏, 禁止用吹風機吹幹
- ◆ 產品如有破損, 禁止使用

Incontinence Nursing

失禁護理



Anti Bedsore Displacement Diaphragmatic Pad

防褥瘡移位隔尿墊

Model: NAF

Features:

- 8 handbags for easy multi-directional movement
- Multi purpose, turn over Pad + urine pad in one
- Oxford cloth is used, which is strong, practical and not easy to break
- Absorbent sponge is used inside to prevent incontinence
- Easy to store and clean
- Suitable for people with mobility difficulties, long-term bedridden and disabled
- 8條手提袋,方便多方位移動
- 一帶多用,翻身墊+尿墊合一
- 採用牛津布,受力度大、實用、不易斷裂
- 內裡採用吸水海綿,防止失禁尿液
- 易於收納,清潔方便
- 適用於行動不便、長期臥床、殘障人士



Specifications

Product Model 產品型號	NAF
Product Material 產品材質	waterproof oxford cloth 防水牛津布
Product Function 產品功能	turning over, shifting, urination 翻身、移位、隔尿
Specifications 規格	average code 均碼
Product Color 產品顏色	blue+black 藍+黑
Product Size 產品尺寸	120*72*3cm
Product Weight 產品重量	687g
Package Size 包裝收納尺寸	26.5*19*16cm
Packing Weight 包裝重量	0.81kg

Instructions

- ◆ 將產品取出放置於床上讓病人躺在上面即可
- ◆ 需要移床時抓住手提位移動即可

注意事項:

- ◆ 請遠離火源或高溫環境;以免造成產品損壞,影響使用壽命
- ◆ 遠離潮濕環境,以免滋生細菌
- ◆ 可用清水和洗滌劑清洗,不要用腐蝕性液體等

Waterproof Rollover Shift Pad

防水翻身移位墊

Model: NBX/NBX2

Features:

- Single operation, convenient and labor-saving, no waist injury, flexible use
 - Transfer and roll over easily, comfortable and labor-saving
 - Urine-proof and water-proof, assisted to roll over, TPU waterproof cloth on the back, effective waterproof and anti-urine
 - Applicable to: people with mobility difficulties, long-term bedridden, and disabled
-
- 單人操作, 方便省力, 不傷腰身, 使用靈活
 - 轉移翻身, 輕鬆翻身, 舒適省力
 - 隔尿防水, 輔助翻身, 背面為TPU隔水布, 有效防水防尿
 - 適用於: 行動不便、長期臥床、殘障人士

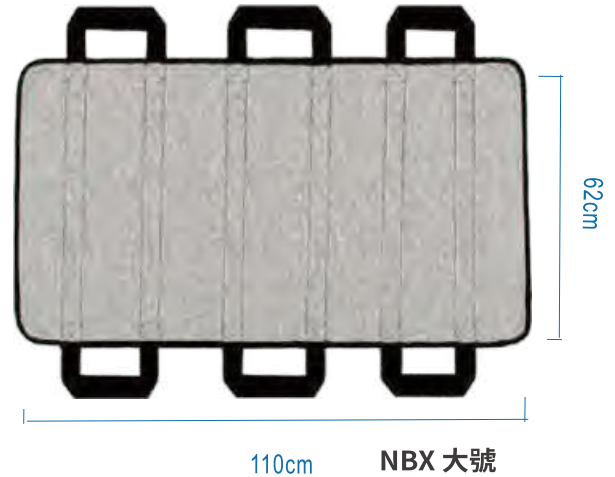

Specifications

Product Model 產品型號	NBX/NBX2
Product Material 產品材質	cotton+tpu waterproof layer 純棉+TPU防水層
Product Function 產品功能	turning over, shifting, urination 翻身、移位、隔尿
Specifications 規格	Large/Medium 大號/中號
Product Color 產品顏色	grey 灰色
Bearing 承重	< 100KG
Product Size 產品尺寸	110*62cm / 80*22cm
Product Weight 產品重量	778g / 143g

Instructions

- ◆ 將產品取出放置於床上讓病人躺在上面即可
- ◆ 需要移床時抓住手提位移動即可

注意事項:

- ◆ 請遠離火源或高溫環境; 以免造成產品損壞, 影響使用壽命
- ◆ 遠離潮濕環境, 以免滋生細菌
- ◆ 可用清水和洗滌劑清洗, 不要用腐蝕性液體等

Turn Over Nursing Belt

翻身護理帶

Model: NAC

Features:

- Suitable for home care and help patients with heavier weight
- The operation is more convenient, and it can be operated by turning around and pulling
- The turning angle can be changed at will, and the effect of anti-bedsores is better
- Use waterproof and anti-friction materials to reduce friction with the bed surface
- Suitable for: nursing, helping patients, assisting in changing diapers and clothes, etc
- 適合居家人手不足和臥床病人體重較重的使用
- 操作更方便, 左右翻身一拉就可操作
- 翻身角度可隨心變換, 防褥瘡效果更好
- 採用防水防摩擦材質, 減輕與床面摩擦力
- 適用於: 護理、幫助病人, 輔助換尿褲和衣服等

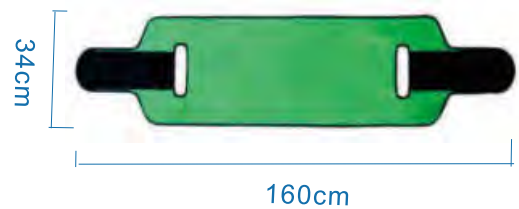

Specifications

Product Model 產品型號	NAC
Product Material 產品材質	oxford cloth + shredded milk 牛津布+牛奶絲
Product Function 產品功能	assisted roll over 輔助翻身
Product Bearing 產品承重	100kg
Product Size 產品尺寸	160*34*1cm
Product Weight 產品重量	300g
Package Size 包裝尺寸	30*21.5*5cm
Packing Weight 包裝重量	0.37kg

Instructions

- ◆ 將產品取出鋪開在床上或者從病人身體下麵穿過
- ◆ 將兩邊釦手處合攏, 用力往側邊或者坐立方向拉動即可
- ◆ 可以用產品將病人往側邊拉動, 然後粘貼固定在床邊扶手或者床沿處
- ◆ 可以放在腿部幫助腿部訓練等

注意事項:

- ◆ 遠離潮濕環境, 以免滋生細菌
- ◆ 請遠離火源或高溫環境; 以免造成產品損壞, 影響使用壽命
- ◆ 可用清水和洗滌劑清洗, 不要用腐蝕性液體等

Medical silicone urine connector

醫用矽膠接尿器

Model: NAA

Features:

- Lightweight and breathable, fixed and widened waistband, adjustable in size
- Liquid silicone has excellent hydrophobicity, softer and more durable
- The anti-backflow soft edge fits better, and the anti-leakage effect is better
- Ventilation holes on both sides, internal heat dissipation naturally
- Applicable crowd: people with mobility difficulties
- 輕薄透氣彈性固定腰帶
- 可循環使用, 加厚導尿管, 臥床防漏
- 4cm加寬彈力腰帶, 多個扣孔, 可調大小
- 液體矽膠具有優良的疏水性柔軟更耐用
- 防回流軟邊能讓接尿器和身體更加貼合, 防漏效果更好
- 為保障透氣充分, 兩側開了透氣孔, 內部熱氣即可自然散出
- 適用人群: 行動不便的人士

Specifications

Product Model 產品型號	NAA
Product Material 產品材質	medical silicone glue 醫用矽膠
Product Function 產品功能	urine receiver 接尿器
Drainage Bag 引流袋	1000ml / 2000ml
Drainage Tube 引流管	1m
Men's waist 男款適用腰圍	84-95cm (2尺5-2尺8)
Women's waist 女款適用腰圍	70-84cm (2尺-2尺5)
Product Size 產品尺寸	18*15*7cm
Product Weight 產品重量	205g
Package Size 包裝尺寸	20*10*10cm
Packing Weight 包裝重量	0.26kg

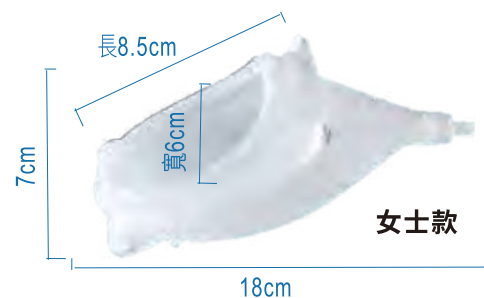
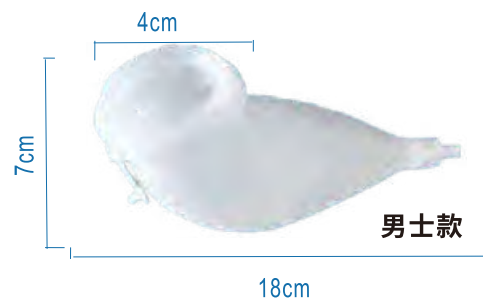

Instructions

- ◆ 將液體矽膠尿囊放入網狀固定腰帶中, 把鈕扣固定
- ◆ 將導尿管分別固定在接尿囊下端口和接尿袋上
- ◆ 將固定腰帶按正確位置擺好, 並扣上扣子
- ◆ 將鬆緊帶從胯下穿過並扣在腰帶上
- ◆ 溫馨提醒: 接尿帶一定要放置比尿囊低的位置

注意事項:

- ◆ 請勿生拉硬拽接尿門與短褲連接扣
- ◆ 側臥使用時可在雙腿間放置小枕頭, 讓雙腿間有一定間隔, 避免雙腿將漏斗擠扁引起漏尿
- ◆ 尿袋一定要放在床下, 尿液是往下流的
- ◆ 注意導管是否有彎折, 過於彎折會導致尿液流通不暢
- ◆ 使用前一定要先關閉排放口
- ◆ 本產品連續使用時間建議不能超過7天

Household Urinal / Night Pot For Men And Women

家用款男女款小便壺/夜壺

Model: NAS

Features:

- With portable handle, easy to carry
 - There is a scale for easy measurement
 - Covered, anti-tipping liquid
 - The product is non-toxic, has no cold feeling in contact, and is easy to clean
 - Suitable for people with limited mobility or difficulty getting out of bed
- 具有手提柄, 方便攜帶
 - 有刻度, 便於測量
 - 有蓋, 防打翻液體
 - 產品無毒害, 接觸無冷感, 清洗方便
 - 適用人群: 行動不便或難以下床人士使用



Specifications

Product Model 產品型號	NAS
Product Material 產品材質	plastic 塑膠
Product Function 產品功能	potty / chamber pot 便壺/夜壺
Product Capacity 產品容量	1200ml / 1000ml
Product Size 產品尺寸	23*13*9cm
Product Weight 產品重量	190g
Package Size 包裝尺寸	26*19*16cm
Packing Weight 包裝重量	0.32kg

Instructions

注意事項:

- ◆ 適用家庭清潔劑清洗
- ◆ 切忌勿用氯化物漂白劑消毒
- ◆ 使用後請及時清理
- ◆ 請遠離火源, 避免與鋒利的物品接觸, 以免影響使用

Plastic Toilet Basin With Cover And Handle

塑膠帶蓋帶手柄大便器護理盆

Model: NAU

Features:

- Handle design on the back, easy to take and hold
 - Can bear 115 kg weight
 - The product is smooth and easy to clean
 - Applicable to: people with limited mobility or difficulty getting out of bed
-
- 具有手柄, 方便拿取
 - 後旁設扶手設計, 方便抓緊及攜帶
 - 可承受115公斤重量
 - 產品光滑, 容易清潔
 - 適用於: 行動不便或難以下床人群使用



Specifications

Product Model 產品型號	NAU
Product Material 產品材質	ABS
Product Function 產品功能	household toilet 家用款護理大便器
Product Bearing 產品承重	115kg
Color 顏色	light blue 淺藍色
Product Size 產品尺寸	35.5*27*11cm
Product Weight 產品重量	310g
Package Size 包裝尺寸	40*30*20cm
Packing Weight 包裝重量	0.84kg

Instructions

- 注意事項:
- ◆ 適用家庭清潔劑清洗
 - ◆ 切忌勿用氯化物漂白劑消毒
 - ◆ 使用後請及時清理
 - ◆ 請遠離火源, 避免與鋒利的物品接觸, 以免影響使用

Washable Non Slip Diaphragms

可清洗防滑式隔尿墊

Model: NAZ / NAZ2 / NAZ3

Features:

- Four layer urine barrier, effective leak proof
 - The material is soft and comfortable, close to the skin, breathable and not muggy
 - Washable, non fading, non slip and non displacement
 - Function: prevent urine and body fluid from polluting bed sheets or bedding, and can be used directly on the skin
 - Applicable to: the elderly, pregnant women, children, menstruation, etc
- 四層隔尿, 有效防漏
 - 材料柔軟舒適, 親膚透氣不悶熱
 - 可水洗, 不掉色, 使用防滑不移位
 - 作用: 阻隔尿液、體液等污染床單或被褥, 可直接貼膚使用
 - 適用於: 老人、產婦、兒童、經期等

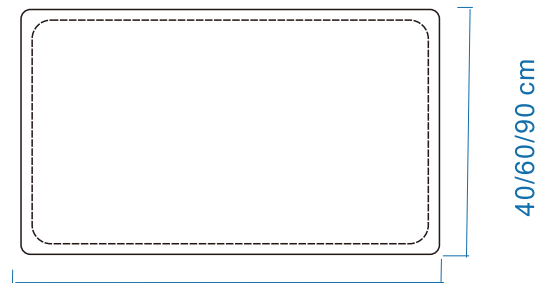

45/90/150 cm

40/60/90 cm

Specifications

Product Model 產品型號	NAZ / NAZ2 / NAZ3
Product Material 產品材質	polyester fiber, breathable mesh, absorbent cotton, TPU 聚酯纖維, 透氣網布, 吸水棉, TPU防水膜
Product Function 產品功能	barrier liquid 阻隔液體
Color 顏色	navy 藏青色
Product Size 產品尺寸	60*90cm / 40*45cm / 90*150cm
Product Weight 產品重量	365g / 98.3g / 700g
Package Size 包裝尺寸	25.5*20*7cm
Packing Weight 包裝重量	0.488kg

Instructions

- ◆ 取出後將產品放置於腰臀部即可
- ◆ 清洗時按照正常清洗方式就可以

注意事項:

- ◆ 皮膚過敏者慎用
- ◆ 對產品材料過敏者慎用
- ◆ 應存放於乾燥和通風良好的室內, 勿於酸鹼等腐蝕性物質混放
- ◆ 遠離高熱、火源等環境
- ◆ 產品使用後請及時更換清洗, 以免滋生細菌

Intelligent Urination Nursing Instrument

智能大小便護理儀

Model: NBI

Features:

- The carrier realizes the functions of automatic induction, collection, washing and drying
- Ad hoc odor elimination function and noise elimination function
- The special mattress can be used with the nursing bed to turn over, lift and drop legs, so as to breathe and keep warm and reduce the occurrence of bed sore
- Applicable to: postoperative bedridden patients, disabled or paralyzed persons, bedridden elderly, etc
- Application: family, nursing home, hospital, rehabilitation center, etc
- 自動感應、收集、沖洗、烘乾功能實現的載體
- 特設的消除臭味功能, 消除噪音功能
- 專用床墊, 可配合護理床實現翻身、起身抬腿、落腿等, 透氣、保暖, 減少褥瘡的發生
- 適用於: 術後臥床病人、傷殘或癱瘓人士、臥床老人等
- 應用於: 家庭、養老院、醫院、康復中心等



臥便器



專用床墊

Specifications

Product Model 產品型號	NBI
Product Material 產品材質	plastic + cotton cloth + brown pad + sponge 塑膠+棉布+棕墊+海綿
Product Function 產品功能	bed rest defecation care 臥床大小便護理
Water Tank Capacity 水箱容量	clean water bucket: 6000ml, dirty water bucket: 7000ml 清水桶: 6000ml, 污水桶: 7000ml
Negative Pressure 負壓	urine negative pressure: 1-3, stool negative pressure: 3-5 小便負壓: 1-3檔, 大便負壓: 3-5檔
Working Mode 模式選擇	automatic or manual 自動或手動
Flushing Water Temperature 沖洗水溫	34-39 °C
Drying Temperature 烘乾氣溫	40-55 °C
Host Size 主機尺寸	80*60*65cm
Host Weight 主機重量	35kg

Instructions

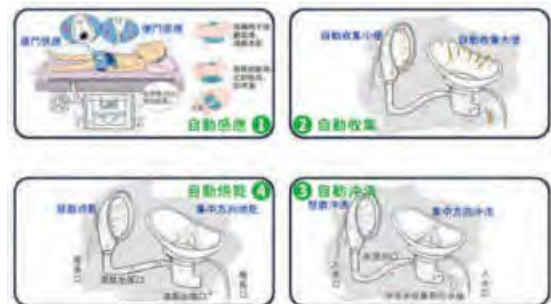

產品概述: 當使用者排出大小便時, 儀器的臥便器自動感知, 主機立即啟動抽取大小便並存儲在汙物桶內, 大小便結束後, 潔淨的溫水自動噴出, 沖洗使用者的隱私部位和集便器內部, 沖洗後立即進行暖風烘乾。

Disposable Sanitary Care Pad

一次性衛生護理墊

Model: NBJ

Features:

- Breathable PE bottom film, double ventilation and effectively reveal moisture
- No fluorescent agent, safe and environment-friendly, high-quality raw materials are selected to protect health
- It looks dry and comfortable all night without being greasy
- Scope of application: cushion bed for operation, postpartum care, menstrual care, use of diaphragms for infants and young children, use of long-term bedridden persons, etc
- 透氣PE底膜, 加倍透氣, 有效透出濕氣
- 不含螢光劑, 安全環保, 選用優質原料, 守護身體健康
- 看的見的乾爽, 整晚舒爽不黏膩
- 適用範圍: 手術用墊床、產後護理、經期護理、嬰幼兒隔尿墊使用、長期臥床者使用等護理使用

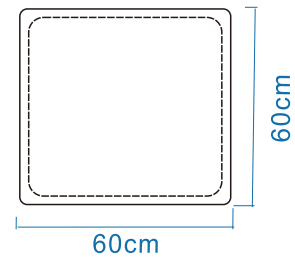

Specifications

Product Model 產品型號	NBJ
Product Material 產品材質	non woven fabric, absorbent paper, wood pulp cotton, SAP polymer, PE film 無紡布、吸水紙、木漿棉、SAP高分子、PE膜
Product Function 產品功能	barrier liquid 阻隔液體
Spec 產品規格	10 Piece pack 10片裝
Product Size 產品尺寸	60*60cm

Instructions

- ◆ 將產品取出後用在相應部位平鋪開即可
- ◆ 展開產品花紋面向上, 貼近使用部位

注意事項:

- ◆ 本品為一次性衛生用品, 請不要反復使用, 不宜與電毯等一起使用
- ◆ 請將本品放置於嬰幼兒無法觸及的地方, 以免發生意外
- ◆ 請置於常溫處保存, 避免高溫、潮濕、陽光照射
- ◆ 本品不溶於水請勿丟入馬桶內
- ◆ 使用過程中如有不適, 請立即停止使用, 並向醫生諮詢

Adult Diapers

成人紙尿褲

Model: NBK

Features:

- 1800ml large suction worry free, regular replacement, one piece a night without getting up at night
- Imported fluff pulp, containing imported polymer water absorption factor, water locking and no reverse osmosis
- Double three-dimensional protection, according to ergonomic design, effectively prevent side leakage
- Breathable bottom film, breathable and dry
- Suitable for: Patients after operation, physiological period, paralyzed patients, unable to take care of themselves and other patients
- 1800ml大吸量無憂定期更換，一晚一片不起夜
- 進口絨毛漿，內含進口高分子吸水因數，鎖水不反滲
- 雙重立體防護，根據人體工學設計，有效防側漏
- 透氣底膜透氣乾爽
- 適用於：手術後患者、生理期、癱瘓患者、無法自理等患者使用



Specifications

Product Model 產品型號	NBK
Product Material 產品材質	Non woven fabric, high polymer water absorbent resin, water absorbent paper, image tendon, fluff pulp, breathable bottom membrane 無紡布、高分子吸水樹脂、吸水紙、像筋、絨毛漿、透氣底膜
Water absorption value 吸水量值	≥1800m
Hip size 臀圍尺碼	80-110cm
Spec 產品規格	L,10 Piece pack L,10片裝

Instructions

- ◆ 在陪護人員的幫助下將產品取出穿上開即可

注意事項：

- ◆ 本品為一次性衛生用品，請不要反復使用
- ◆ 請將本品放置於嬰幼兒無法觸及的地方，以免發生意外
- ◆ 請置於常溫處保存，避免高溫、潮濕、陽光照射
- ◆ 本品不溶於水請勿丟入馬桶內
- ◆ 使用過程中如有不適，請立即停止使用，並向醫生諮詢。
- ◆ 使用時一定要注意前後正反方向，前方粘貼時一定要粘貼牢固
- ◆ 穿戴完成後請整理一下前後腰間和大腿內側的防漏隔邊，以防沒整理好導致漏尿現象

Adult Diapers

成人紙尿褲

Model: NBL

Features:

- It contains imported high polymer water absorption factor, once urine volume of 3S, water absorption and no reverse osmosis
- Double three-dimensional protection, according to ergonomic design, effectively prevent side leakage
- Leak proof and breathable bottom film is breathable and dry
- Suitable for: Patients after operation, physiological period, paralyzed patients, unable to take care of themselves and other patients
- 內含進口高分子吸水因數, 1次尿量3S吸鎖水不反滲
- 雙重立體防護根據人體工學設計, 有效防側漏, 全方位安心呵護
- 防漏透氣底膜透氣乾爽, 產品吸收液體後與床單接觸處依舊乾爽
- 適用於: 手術後患者、生理期、癱瘓患者、無法自理等患者使用



Specifications

Product Model 產品型號	NBL
Product Material 產品材質	Non woven fabric, high polymer water absorbent resin, water absorbent paper, image tendon, fluff pulp, breathable bottom membrane 無紡布、高分子吸水樹脂、吸水紙、像筋、絨毛漿、透氣底膜
Water absorption value 吸水量值	≥1800m
Spec 產品規格	M/L 10 Piece pack M/L 10片裝
Product Size 產品尺寸	M:80*65mm L: 90*75cm

Instructions

- ◆ 在陪護人員的幫助下將產品取出穿上開即可

注意事項:

- ◆ 本品為一次性衛生用品, 請不要反復使用
- ◆ 請將本品放置於嬰幼兒無法觸及的地方, 以免發生意外
- ◆ 請置於常溫處保存, 避免高溫、潮濕、陽光照射
- ◆ 本品不溶於水請勿丟入馬桶內
- ◆ 使用過程中如有不適, 請立即停止使用, 並向醫生諮詢。
- ◆ 使用時一定要注意前後正反方向, 前方粘貼時一定要粘貼牢固
- ◆ 穿戴完成後請整理一下前後腰間和大腿內側的防漏隔邊, 以防沒整理好導致漏尿現象

Concealed Urine Bag Messenger Bag

隱蔽式尿袋斜挎包

Model: NDH

Features:

- Fashionable appearance, hidden urine bag, adjustable shoulder strap length
- The drainage bag is fixed with a lanyard to prevent sagging and backflow
- The bottom end is designed with velcro, which can be opened to release liquid
- Lined with waterproof fabric to prevent soiling
- 外觀時尚, 隱藏尿袋, 肩帶的長短可以調節
- 系繩固定引流袋, 防止下垂倒流
- 底端魔术貼設計, 整體打開釋放出液體
- 內襯防水面料, 防止弄髒衣服



Specifications

Product Model 產品型號	NDH
Product Material 產品材質	mesh+waterproof lining 網+防水內襯
Product Function 產品功能	hide urine bag 隱藏尿袋
Color 顏色	black 黑色
Product Size 產品尺寸	29*19cm
Product Weight 產品重量	105g
Package Size 包裝尺寸	15*15*5cm
Packing Weight 包裝重量	0.16kg

Instructions

注意事項:

- ◆ 請勿使用金屬清潔球等尖銳物品進行清洗;
- ◆ 使用後請及時洗淨晾乾;
- ◆ 請勿長期置於高溫場所, 以免變形;
- ◆ 請勿接觸明火及腐蝕性液體。

Baby Nursing

嬰兒護理



Anti Spitting Triangle Baby Pillow

防吐奶三角嬰兒枕

Model: NCA

Features:

- The fabric is made of 3D air cloth, which is delicate, soft and comfortable
- Memory cotton inner core to enhance air permeability
- Invisible zipper design, exquisite lathe work
- It is made of polymer waterproof and breathable materials, which is comfortable and dry
- Applicable population: infants (3 months to 3 years old)

- 面料採用3D空氣布料，質地細膩，柔軟舒適
- 記憶棉內芯，增強透氣透氣性
- 隱形拉鍊設計，精緻車工
- 高分子防水透氣材質複合而成，舒適乾爽
- 適用人群：嬰兒（3個月-3歲）

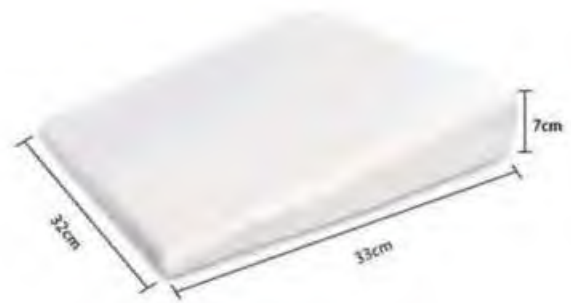

Specifications

Product Model 產品型號	NCA
Product Material 產品材質	memory cotton + 3D air layer fabric 記憶棉+3D空氣層面料
Product Function 產品功能	raise position 抬高體位
Color 顏色	white 白色
Cleaning Method 清洗方式	removable cleaning 可拆卸清洗
Product Size 產品尺寸	33*32*7cm
Product Weight 產品重量	0.33kg

Instructions

- ◆ 將產品取出來放置於寶寶需要躺的地方即可
- ◆ 清洗時將拉鍊拉開方可清洗

注意事項：

- ◆ 此款為棉質產品請遠離火源或高溫環境，以免造成產品損壞，以防影響使用壽命
- ◆ 遠離潮濕環境，以免滋生細菌
- ◆ 外套可以直接水洗

Triangular Side Sleeping Baby Pillow

三角側睡嬰兒枕

Model: NCB

Features:

- The Velcro positioning design is flexible and adjustable, and the distance can be adjusted according to the needs of the baby
- The coat can be disassembled and washed for convenient washing
- Velvet coat is soft and comfortable
- Invisible zipper design to prevent the zipper from scratching the baby
- Applicable population: infants (3 months to 3 years old)
- 魔術貼定位設計靈活可調節的寬度,可根據寶寶需要調節距離
- 外套可拆洗枕套枕芯可折開,方便洗滌,睡得更衛生天鵝絨
- 外套柔軟舒適,寶寶不敏感,睡得更舒適
- 隱形拉鍊設計,防止拉鍊劃傷寶寶
- 適用人群:嬰兒(3個月-3歲)



Specifications

Product Model 產品型號	NCB
Product Material 產品材質	Flat velvet + high density sponge 平面天鵝絨+高密度海綿
Product Function 產品功能	fixed position 固定體位
Color 顏色	light blue 淡藍色
Adjustment Range 調節範圍	0~22cm
Product Size 產品尺寸	42cm*22cm*10cm
Product Weight 產品重量	230g
Package Size 包裝尺寸	50*10*11cm
Packing Weight 包裝重量	0.265kg

Instructions

- ◆ 取出後將產品放置於腰臀部位即可
- ◆ 清洗時按照正常清洗方式就可以

注意事項:

- ◆ 皮膚過敏者慎用
- ◆ 對產品材料過敏者慎用
- ◆ 應存放於乾燥和通風良好的室內,勿於酸鹼等腐蝕性物質混放
- ◆ 遠離高熱、火源等環境
- ◆ 產品使用後請及時更換清洗,以免滋生細菌

Children's Folding Washbasin

兒童折疊臉盆

Model: NCC

Features:

- Hanging design, hanging drainage and good storage
- PP5 material, reassuring and no smell, baby can use it at ease
- Folding design, thin to 4cm, saving space
10cm basin depth, 4000ml water capacity
- The whole pelvic floor has been thickened, which is resistant to pressure and fall, and can be used for a longer time
- Applicable to: face washing and asshole washing in infants and young children, as well as special care period
- 可懸掛設計, 懸掛瀝幹好收納
- PP5材質, 安心無異味, 寶寶放心使用
- 折疊設計, 薄至4CM, 節省空間
- 10CM盆深, 4000ML水容量
- 盆底整體做了加厚處理, 抗壓耐摔, 使用更久
- 適用於: 嬰幼兒時期洗臉、洗屁屁等, 也可用於特殊護理期等

Specifications

Product Model 產品型號	NCC
Product Material 產品材質	PP5
Color 顏色	yellow 黃色
Applicable 適用	0-8 years old 0-8歲
Product Size 產品尺寸	33*21.5*10cm
Product Weight 產品重量	210g
Package Size 包裝尺寸	41*45*10cm
Packing Weight 包裝重量	0.63kg



Instructions

- ◆ 將產品取出後拉開折疊部分即可使用
- ◆ 不使用時將產品折疊即可, 也可以折疊後懸掛在掛鉤處

注意事項:

- ◆ 對產品材料過敏者慎用
- ◆ 應存放於乾燥和通風良好的室內, 勿於酸鹼等腐蝕性物質混放
- ◆ 遠離高熱、火源等環境

Baby Pentagonal Bathing Net Bag

嬰兒五角沐浴網兜

Model: NCD

Features:

- The five corner anti slip design is safe and firm to prevent the baby from sliding into the water
- Smooth lines, fit the baby's back, reasonable support and safer
- Adjustable length: the length of the bath net can be adjusted by crimping the buckle
- It is thickened and soft to protect the small head. It is soft and elastic, and the baby is more comfortable to take a bath
- Applicable to: babies aged 0-18 months
- 五角防滑設計,安全牢固,防止寶寶滑入水中
- 流暢線條,貼合寶寶背部,合理承托更安全
- 可調節長短:通過捲縮浴網兩邊的卡扣可調節浴網的長度控制寶寶到水面的距離
- 加厚柔軟,保護小腦袋,柔軟高彈,寶寶洗澡更舒服
- 適用於:0-18個月寶寶

Specifications

Product Model 產品型號	NCD
Product Material 產品材質	Sandwich mesh + loop flannel 三明治網布+圈絨布
Product Function 產品功能	Baby bathing aid 嬰兒洗澡輔助
Color 顏色	Light green 淺綠色
Operation Mode 操作方式	Snap type 卡扣式
Product Size 產品尺寸	47*33*31cm
Product Weight 產品重量	150g
Package Size 包裝尺寸	25.5*20*7cm
Packing Weight 包裝重量	0.232kg



Instructions

- ◆將產品取出,將5條卡扣帶按照對應的位置卡在浴盆的邊緣,可根據所需長度來調節使用長度
- ◆調節長短時直接向一方卷起即可
- ◆請使用後擰幹水,放置於通風處

注意事項:

- ◆對產品材料過敏者慎用
- ◆應存放於乾燥和通風良好的室內,勿於酸鹼等腐蝕性物質混放
- ◆遠離高熱、火源等環境
- ◆產品使用後請及時更換清洗,以免滋生細菌
- ◆使用時請確認卡扣已經全部卡到位,以免發生意外

Infant Urinary Pad

嬰兒隔尿墊

Model: NCE

Features:

- 100% cotton gauze on the surface+middle absorbent layer+bamboo cotton terry bottom, soft and anti-slip
- Cotton double-needle binding, more durable and machine washable
- Skin-friendly design, soft and breathable, waterproof and urine barrier
- Multi-functional baby urinal pad, baby stroller pad
- 表面100%純棉紗布+中間吸水層+竹棉毛圈底部, 柔軟防滑
- 純棉雙針包邊, 更耐用可機洗
- 親膚設計, 柔軟透氣, 防水隔尿
- 多功能寶寶隔尿墊、外出嬰兒推車墊



Specifications

Product Model 產品型號	NCE
Product Material 產品材質	cotton+bamboo cotton terry+polyester 棉+竹棉毛圈+聚酯纖維
Product Function 產品功能	infant urinary septum 嬰兒隔尿
Color 顏色	random 隨機
Product Size 產品尺寸	45cm*29.5cm*0.5cm
Product Weight 產品重量	0.08kg
Package Size 包裝尺寸	15*15*5cm
Packing Weight 包裝重量	0.42kg

Instructions

- ◆ 取出後將產品放置於腰臀部位即可
- ◆ 清洗時按照正常清洗方式就可以

注意事項:

- ◆ 對產品材料過敏者慎用
- ◆ 應存放於乾燥和通風良好的室內, 勿於酸鹼等腐蝕性物質混放
- ◆ 遠離高熱、火源等環境
- ◆ 產品使用後請及時更換清洗, 以免滋生細菌

Suede Waterproof Baby Care Mattress

絨面嬰兒防水護理床墊

Model: NCF

Features:

- Tough and washable, easy to wash without deformation
 - Skin-friendly design, soft and breathable, waterproof and urine barrier
 - One pad can be used for many purposes and can be carried out
- 韌耐水洗, 易洗不變形
 - 親膚設計, 柔軟透氣, 防水隔尿
 - 一墊多用, 可外出攜帶



Specifications

Product Model 產品型號	NCF
Product Material 產品材質	crystal super soft velvet+tpu waterproof film+ecological cotton 水晶超柔絨+TPU防水膜+生態棉
Product Function 產品功能	infant urinary septum 嬰兒隔尿
Product Size 產品尺寸	118.7cm*68.5cm*0.5cm
Product Weight 產品重量	0.24kg
Package Size 包裝尺寸	24cm*17cm*5cm
Packing Weight 包裝重量	0.32kg

Instructions

- ◆ 取出後將產品放置於腰臀部位即可
- ◆ 清洗時按照正常清洗方式就可以

注意事項:

- ◆ 對產品材料過敏者慎用
- ◆ 應存放於乾燥和通風良好的室內, 勿於酸鹼等腐蝕性物質混放
- ◆ 遠離高熱、火源等環境
- ◆ 產品使用後請及時更換清洗, 以免滋生細菌

Medical Tools

醫用工具

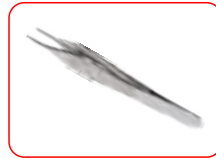

Daily Cystostomy With Urine Bag

日用款膀胱造口接尿袋

Model: NDB

Features:

- Latex material, reusable, high elastic webbing length adjustable
- Adjustable belt and fixing ring are integrated, easy to use
- Latex connected to urine bucket, leak-proof crimping design, preventing leakage and countercurrent
- Applicable to: patients with ileum, colon, rectum or urethrostomy are used to receive excreta after operation
- 乳膠材質, 可反復使用, 高彈力腹帶長度可調
- 調節腰帶和固定圈一體, 使用方便
- 乳膠接尿門, 防漏卷邊設計, 防止漏液逆流
- 適用於: 回腸、結腸、直腸或尿道造口患者術後接裝排泄物使用

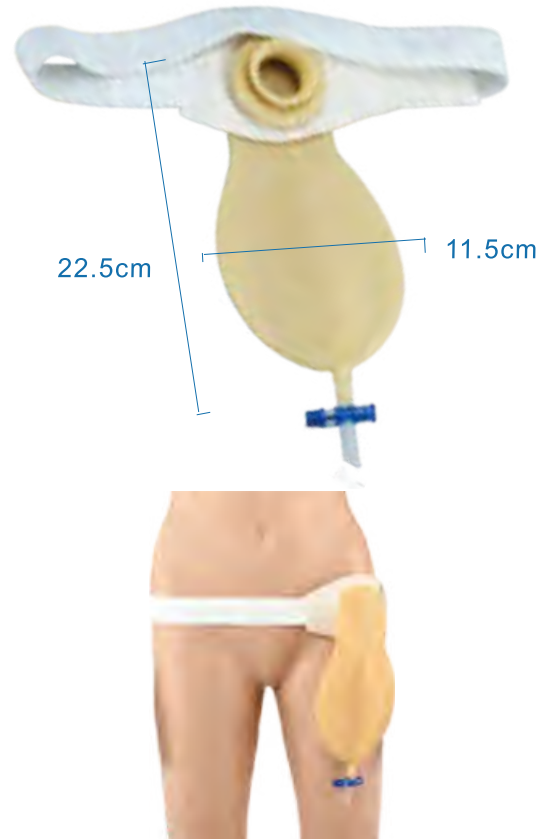

Specifications

Product Model 產品型號	NDB
Product Material 產品材質	latex 乳膠
Product Size 產品尺寸	daily urine collection bag: 22.5 * 11.5cm cross valve: 6 * 4cm belt: 90 * 4cm 日用接尿袋: 22.5*11.5cm 十字閥: 6*4cm 腰帶: 90*4cm
Product Weight 產品重量	109g
Package Size 包裝尺寸	15*15*5cm
Packing Weight 包裝重量	0.16kg

Instructions

◆將介面中間溝槽按壓卡進腹帶, 將儲液袋調整和腹部垂直, 將乳膠口對準造口, 拉緊腹帶, 使用中提拉儲液袋防止粘連及時打開排尿口排尿、減輕重量

注意事項:

- ◆腰掛袋適用於白天使用, 患者帶上後便於行動和工作, 不需要配合儲尿袋使用。儲尿袋掛在床邊、切勿放在床上、外出使用可將儲尿袋綁在腿上。使用時應經常沖洗晾乾、忌暴曬、烘烤、固定腹帶鬆緊要適度。對乳膠過敏者慎用。
- ◆本品配置的膠片建議粘貼使用3天左右, 延期使用會影響粘貼效果, 導致脫落或滲漏, 並對皮膚不利;
- ◆如果袋子出現脹氣情況, 請在袋體上端用針紮孔排氣, 建議使用活性炭過濾片貼在排氣孔上, 可去除異味;
- ◆皮膚對粘膠過敏者慎用, 如在使用過程中感到不適, 請立即停止使用, 並向醫療專業人士諮詢;
- ◆腹帶兩件式造口袋, 建議造口皮膚恢復好以後使用, 平型和凹陷型等非外凸型造口請慎用。
- ◆使用時應經常沖洗晾乾, 忌暴曬、烘烤, 固定腹帶鬆緊要適度。對乳膠過敏者甚用。

Disposable Belt Type Anorectal Pouch

一次性腰帶式肛腸造口袋

Model: NDC

Features:

- Fish silk fabric, comfortable, breathable and not stuffy
- Blue waterproof cloth, easy to clean
- 16cm special ejection hook, adjust the tightness freely, not easy to fall off
- Fixed clip design, rotatable chassis, so that patients can be used in sitting, lying, standing and other positions
- Applicable to: stoma cleaning, nursing and excreta collection
- 魚絲面料, 舒適透氣不悶熱
- 藍色防水佈, 易清潔
- 16cm專用射出鉤, 隨心調節鬆緊度, 不易脫落
- 固定夾子設計, 可旋轉式底盤, 讓患者在坐姿、躺姿、站姿等姿勢下均可適用
- 適用於: 造口清洗、護理和排泄物的收集



總長100cm



Specifications

Product Model 產品型號	NDC
Product Material 產品材質	silicone+plastic bag+elastic belt 矽膠+塑膠袋+彈性腰帶
Color 顏色	blue and white 藍白色
Product Size 產品尺寸	belt: 100cm ± 10% long, 6cm wide, with 20cm adjustable buckle inner diameter: 2.5-5cm, can be cut 腰帶: 長100cm±10%, 寬6cm, 有20cm調節粘扣 內徑: 2.5-5cm可剪裁
Product Weight 產品重量	99g
Package Size 包裝尺寸	15*15*5cm
Packing Weight 包裝重量	0.15kg

Instructions

- ◆ 將肛門袋套在肛門圈外沿上, 用卡子卡好或皮筋, 一定要套緊、套牢。
- ◆ 將肛門圈兩邊的布帶圈在腰部, 使肛門圈對準改造口位置, 調節到適宜的緊度, 系好即可。
- ◆ 及時更換肛門袋。

注意事項:

- ◆ 請勿使用金屬清潔球等尖銳物品進行清洗;
- ◆ 使用後請及時洗淨晾乾;
- ◆ 請勿長期置於高溫場所, 以免變形;
- ◆ 請勿接觸明火及腐蝕性液體。

Adjustable Pressure Dialysis Tourniquet

可調節壓力透析止血帶

Model: NDG

Features:

- The length can be adjusted freely, durable, spacious, soft and comfortable
 - High elasticity, no deformation after repeated use
 - Widened Velcro with strong fixation
 - Applicable crowd: special tourniquet for dialysis, with strong adhesion, can be used repeatedly, and can be adjusted freely, fat and thin
- 長度隨意調，經久耐用，寬大柔軟舒服親膚
 - 高彈鬆緊，反復使用不變形
 - 加寬魔术貼，固定性強
 - 適用人群：透析專用止血帶，粘力強反復使用，隨意調節鬆緊，胖瘦都能使用

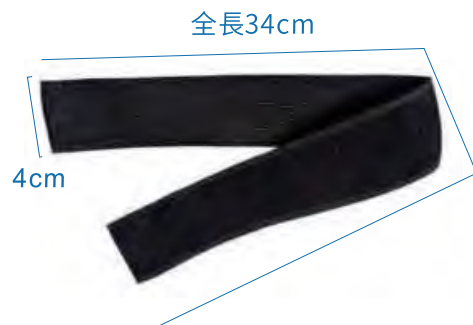

Specifications

Product Model 產品型號	NDG
Product Material 產品材質	high elasticity and tightness 高彈鬆緊
Color 顏色	black 黑色
Product Size 產品尺寸	35*4cm
Product Weight 產品重量	11g
Package Size 包裝尺寸	10*10*3cm
Packing Weight 包裝重量	0.05kg

Instructions

- ◆ 取出產品，根據自己的需求調節大小，粘上魔术貼即可

注意事項：

- ◆ 請勿使用金屬清潔球等尖銳物品進行清洗；
- ◆ 使用後請及時洗淨晾乾；
- ◆ 請勿長期置於高溫場所，以免變形；
- ◆ 請勿接觸明火及腐蝕性液體。、烘烤，固定腹帶鬆緊要適度。對乳膠過敏者禁用。

Stainless Steel Tweezers

不銹鋼鑷

Model: NDQ

Features:

- Fine workmanship, stable clamping and convenient use
- The whole is round, smooth and delicate, without diamond corner and burr

- 精工細作, 夾持穩固, 使用方便
- 整體圓潤光滑細膩, 無菱角, 無毛刺

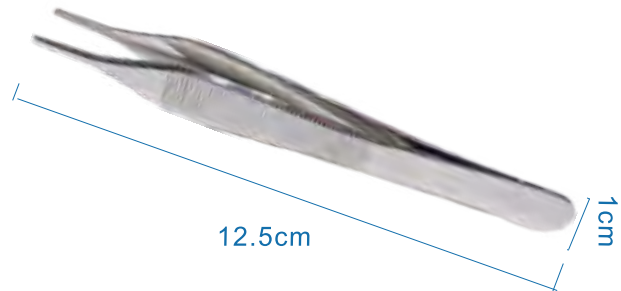

Specifications

Product Model 產品型號	NDQ
Product Material 產品材質	stainless steel 不銹鋼
Product Size 產品尺寸	12.5*1*1.5cm
Product Weight 產品重量	25g
Package Size 包裝尺寸	10*10*3cm
Packing Weight 包裝重量	0.05kg

Instructions

注意事項:

- ◆ 請勿使用金屬清潔球等尖銳物品進行清洗;
- ◆ 使用後請及時洗淨晾乾;
- ◆ 請勿長期置於高溫場所, 以免變形;
- ◆ 請勿接觸明火及腐蝕性液體。

Stainless Steel Straight/curved Scissors

不銹鋼直/彎剪刀

Model: NDR

Features:

- Stainless steel material, thickened steel core, not easy to oxidize
- Double cutting edge, fine grinding and forging, easy to cut
- The finger ring is smooth, circular in shape, not easy to grind
- Polished smooth, the surface is bright and fresh, and the feel is light
- 不銹鋼材質, 加厚鋼芯, 不易氧化
- 雙重開刃, 精細打磨鍛造, 易裁剪
- 指圈圓滑, 做工圓弧, 不易磨手
- 打磨光滑, 表面光新亮麗, 手感輕便



Specifications

Product Model 產品型號	NDR
Product Material 產品材質	stainless steel 不銹鋼
Specifications 規格	straight head and elbow 直頭、彎頭
Product Size 產品尺寸	10.5*4.5cm
Product Weight 產品重量	18g~15g
Package Size 包裝尺寸	10*10*3cm
Packing Weight 包裝重量	0.05kg

Instructions

注意事項:

- ◆ 請勿使用金屬清潔球等尖銳物品進行清洗;
- ◆ 使用後請及時洗淨晾乾;
- ◆ 請勿長期置於高溫場所, 以免變形;
- ◆ 請勿接觸明火及腐蝕性液體。

Stainless Steel Straight/curved Hemostatic Forceps

不銹鋼直/彎止血鉗

Model: NDS

Features:

- Sawtooth design, tight fit, easy to grip, not easy to drop
 - Round grip, comfortable feel, not easy to deform, not easy to grind
 - Flexible joints, smooth opening and closing, good handle
 - Fixed clamping force, lock tooth design, can be used for hemostasis, winding cotton ball and other functions
-
- 鋸齒設計, 緊密貼合, 容易夾取, 不易掉落
 - 圓潤握把, 手感舒適, 不易變形, 不易磨手
 - 靈活關節, 開合順暢, 使用手感好
 - 固定夾力, 鎖齒設計, 可用於止血纏繞棉球等作用



Specifications

Product Model 產品型號	NDS
Product Material 產品材質	stainless steel 不銹鋼
Specifications 規格	straight head and elbow 直頭、彎頭
Product Size 產品尺寸	12.5*6.5cm
Product Weight 產品重量	26g~20g
Package Size 包裝尺寸	12*12*5cm
Packing Weight 包裝重量	0.07kg

Instructions

注意事項:

- ◆ 請勿使用金屬清潔球等尖銳物品進行清洗;
- ◆ 使用後請及時洗淨晾乾;
- ◆ 請勿長期置於高溫場所, 以免變形;
- ◆ 請勿接觸明火及腐蝕性液體。



Ziglite Smart Health Care Products Co., Ltd.
節亮康護產品有限公司

Hong Kong Office Address

Room B3, 18/F Bonsun Industrial Building, 364-366 Sha Tsui Road, Tsuen Wan, Hong Kong

Office Hour : Mon - Fri : 9:30 - 5:30pm

Email : info@ziglite.com

Office : +852 3107 7500

Fax: +852 3544 0462

Whatsapp : +852 6827 2010



www.ziglite.com

