

手部伸展復康治療器

Hand Stretching Rehabilitation Therapy Device

使用說明書

Instruction Manual



Ziglite Smart Health Care Products Co., Ltd.

節亮康護產品有限公司

Z IGLITE[®]
HEALTHCARE

目 錄

了解產品	02
使用指南	04
安全注意事項	12
產品使用注意事項	13
故障排除	15
技術參數	16
售後服務	17



感謝您選購手部伸展復康治療器。

使用本產品之前，請仔細閱讀本說明書。

請妥善保管本說明書，以便在使用康復治療器時予以指導。

手部伸展復康治療器可提供手部循環和鏡像運動康復訓練，維持並擴大用戶手指關節活動度，防止關節攣縮、肌肉萎縮，對神經系統的重組和代償有極大的促進作用，幫助患者儘快康復。

腦卒中後手功能障礙的恢復是一個長期並且艱苦的過程不同患者的病情，康復療程和療效是有很大差別的。正常情況下手功能的恢復要比其他部位慢一些，需要長期堅持康復訓練。

如果您在使用中有疑問，請聯系：info@ziglite.com

說明書版本可能因軟體版本或者技術規格的變更而陞級，恕不另行通知。

了解產品

適用範圍

適用於受傷後患者的手指關節恢復或由腦損傷、腦卒中、腦癱、脊髓損傷、骨科術後、多發性硬化等引起的肢體障礙後遺症患者在家庭及機構中的康復訓練。

產品組成

治療器主機



ZIGLITE

HEALTH CARE

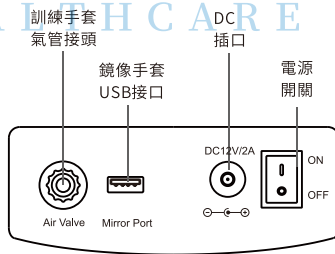
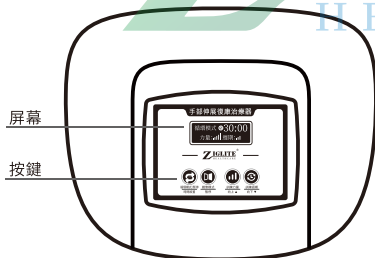

了解產品

訓練手套

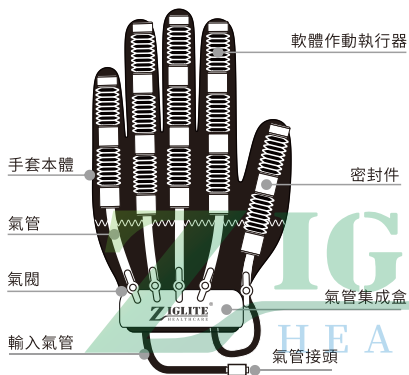

鏡像手套



電源適配器



使用指南

治療器操作按鍵及界面顯示

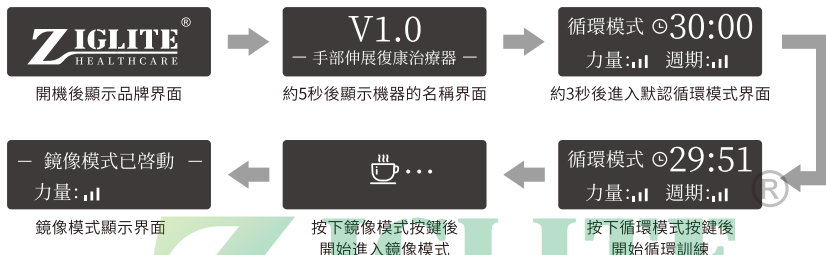

使用指南

治療器按鍵功能，操作界面詳解

循環模式界面

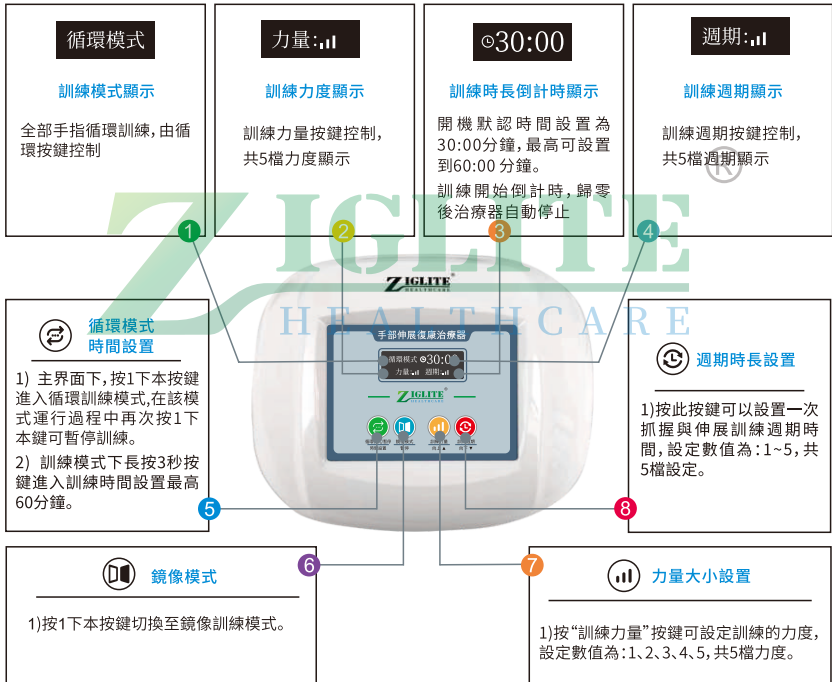

使用指南

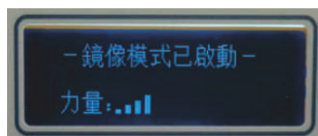

操作界面詳解

鏡像模式界面



力量: . . . |

鏡像模式
力量設置



在鏡像模式下，按下“”和“”
按鍵可對鏡像模式的訓練力度的進行
設定，共5檔力度調整。

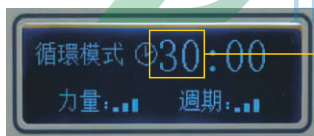

訓練時間設置界面



時間位閃爍

在循環訓練模式下，長按“”鍵3秒進入時間設置模式，這時運動時間位閃爍。
“”和“”鍵可對訓練時間進行加減設定，分鐘設定分度值為5分鐘，訓練時間最高可到60分鐘。

使用指南

使用方法

1



放置好治療器主機

將治療器主機放在桌面，請勿放在潮濕、軟布面、不潔淨的桌面。

2



連接氣管和DC插頭

訓練手套接入時需將氣管接頭順時針旋轉擰緊到主機對應接口。

3



穿戴訓練(鏡像)手套

監護人幫患者戴好手套，將手套腕部貼拉至腕部粘合收緊。

4



治療器開機

向下撥動治療器主機“電源開關”鍵到“1”位置通電開啟，LCD顯示屏點亮，進入。

5



開始手部訓練

按“循環模式/鏡像模式”按鍵隨時開始和暫停訓練。

6



治療器關機

訓練結束，治療器主機“電源開關”鍵撥到“0”位置關閉，LCD斷電。

使用指南

手套接入主機圖示

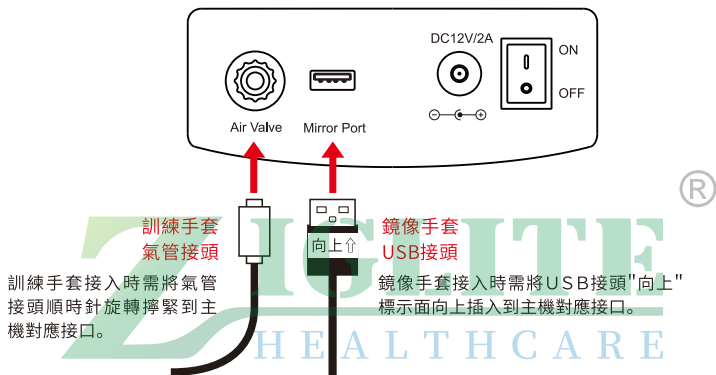

手套接頭接入效果



使用指南

氣閥開關控制

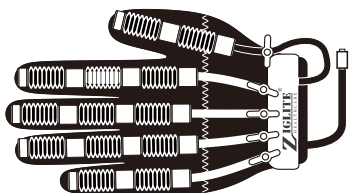

訓練手套的每根手套氣管上都帶單個相互獨立的氣閥開關，可通過該開關的打開或關閉來進行手指針對性選擇訓練。



開啟氣閥

氣閥和氣管方向一致，氣閥為打開狀態，對應手指可進行康復訓練。
氣閥開關默認為開啟狀態。



關閉氣閥

氣閥和氣管方向呈十字形，氣閥為關閉狀態，對應手指不進行訓練。



使用指南

循環訓練模式

循環訓練模式採用全自動化設計，當患者沒有主動控制能力，建議先使用循環訓練，有助於促進患手部屈伸肌肌力恢復，關節活動度增加，促使主動伸指運動出現。

默認循環訓練

<p>1</p> 	<p>1) 穿戴訓練手套 2) 開機後進入訓練主界面</p>	<p>2</p> 	<p>3) 開機後按自動進入默認循環模式,按1下開始訓練,訓練時長30分鐘,週期力量均為第3檔</p>
--	------------------------------------	--	---

力量、週期、時間設置 (不設置時間步驟3可略過)

<p>(1)</p> 	<p>(2)</p> 	<p>(3)</p> 	<p>(4)</p> 
<p> 設置訓練週期 每次按1下設置檔位 共1~5檔</p>	<p> 設置訓練力度 每次按1下設置檔位 共1~5檔</p>	<p> 設置訓練時長 長按3秒進入設置 和對應時間加減 每次點擊加減5分鐘</p>	<p> 開始訓練 按1下按鍵開始訓練</p>

使用指南

鏡像訓練模式

鏡像模式是指患者通過健手運動帶動患手同步運動的模式，通過互動視覺反饋可以刺激患者大腦的不同區域產生運動、感覺意識，啟動鏡像神經元，促進患者運動功能重建與腦功能重塑。

<p>(1)</p>  <p>鏡像手套 訓練手套</p>	<p>穿戴手套，開機</p> <p>患手穿戴好訓練手套 健手穿戴好鏡像手套 開機後進入訓練主界面</p>	<p>(2)</p> 	<p>進入鏡像模式</p> <p>訓練主界面下 按1下  按鍵 進入鏡像模式訓練</p>
<p>(3)</p> 	<p>設置訓練力度</p> <p>每次按1下  設置 訓練力度共1~5檔</p>	<p>(4)</p> 	<p>開始鏡像訓練</p> <p>健手抓握(伸展)運動 發出指令，患手按照指令 進行抓握(伸展)運動</p> <p>注：需抓握按下(鬆開)鏡 像手套內控制按鍵，才能 啟動訓練手套抓握(鬆 開)動作</p>

HEALTHCARE

⚠️ 安全注意事項

【警告】不遵守以下安全說明，可能會導致火災、電擊、傷亡等嚴重事故。

- 請勿自行拆卸或修理、改造設備的各部件避免引起治療器出現異常。
- 請勿在熱水器、微波爐、煮食設備或高壓容器內部或附近存放各部件，避免因過熱而引起火災。
- 不可以滅菌或高壓滅菌。
- 請勿在出現報警提示時繼續使用。
- 適用於手部循環和鏡像運動康復訓練，請勿用於其他目的，避免引起事故發生。
- 請勿將各部件存放在過熱或過冷的地方，避免引起事故發生。
- 產品的有效期為5年，產品在使用壽命末期的處理應符合當地法律法規要求。
- 請保持電源接頭乾燥無水，請不要用濕手去插拔電源，避免引起觸電或受傷。

工作環境

- 1) 環境溫度: 10°C~35°C
- 2) 相對濕度: 30%~75%, 不包含冷凝
- 3) 大氣壓力範圍: 700hpa~1060hpa
- 4) 電源: AC100-240V, 50/60Hz (治療器主機電源DC12V)

存放運輸

- 在運輸過程中，請將治療器固定在相對穩定的地方，防止治療器的碰確和損壞。
- 請防止液體或異物進入治療器，避免損傷內部電子部件，引起故障。
- 請勿在消毒氣體或活性氣體的環境中存放，避免損傷內部電子部件，引起故障。
- 請勿長時間放置在日光或紫外線等強光照射場所，避免引起外殼變色。
- 請勿把本產品放置在嬰幼兒可觸及的地方。
- 保存產品時，請勿在產品上放置其他物品。
- 請勿讓產品觸及釘子、針頭等鋒利物品。
- 請勿將手套強力折疊，避免損傷軟體作動執行器，引起故障。
- 請勿在潮濕環境或強磁場干擾等不適合電子設備工作環境中存放治療器。

後期處理

- 請勿將治療器置入火中銷毀。
- 請勿將治療器作為普通的生活垃圾處理，終末期按照醫療器械標準要求處理，勿隨意丟棄。

ZIGLITE
HEALTHCARE



產品使用注意事項

- 產品使用過程中如發生皮膚過敏等不適，請停止使用，並諮詢醫生。
- 有疾病或傷口或因此正在接受治療的患者，或者有過既往病史的，請熟知以下內容後，諮詢醫生。
- 如手部有扭傷、創傷、情況不明的骨傷、嚴重骨質酥鬆人群、骨折未經處理或處理後需要制動的人群，在未經專業人員確定可用的情況下，請勿擅自使用本產品。

禁忌症

- 有胸部靜脈瘤等重度血行障礙和患有血栓症的患者；
- 患側手上有潰瘍、傷口、膿果、出血、燙傷、炎症等的患者。



其他使用注意事項

- 1) 使用過程中體驗感或身體感到異常時，應停止使用並就醫後在醫生的指導下使用；
- 2) 使用過程中出現發紅、瘙癢、斑疹等，應停止使用並就醫；
- 3) 請勿與其他裝備同時使用或塗抹藥物的狀態下使用；
- 4) 請勿給無行為意識的人或幼童獨自使用；
- 5) 請勿將本產品用於使用目的之外的其他用途。

使用前

- 1) 在穿戴訓練手套前，請試運行治療器主機1分鐘以確認各部分功能正常；
- 2) 強制性收縮痙攣患者，使用治療器前，需先做按摩活動後再使用；
- 3) 注：訓練前請確認需要訓練的手部非肌張力過高（II級以上），方可進行訓練。

產品使用注意事項

使用中

運行過程中發生以下情況，請立即停止使用，並斷開電源!

- 1) 治療器主機發出異常聲音
- 2) 治療器主機表面溫度過高
- 3) 治療器主機進水
- 4) 使用者感到疼痛腫脹或者其他不適症狀
- 5) 訓練過程中如有痙攣發生應立即停止使用

使用時間

- 1) 建議根據自身實際情況，選擇合適的訓練方式
- 2) 每次使用時間不宜過長，訓練後第二天手部如果有酸痛感，則需減少每天訓練次數和時間
- 3) 建議每天使用2-4次，每次20分鐘左右，兩次使用間隔至少45分鐘以上
- 4) 使用時若需要更換或延長使用時間請諮詢專業醫護人員

電源適配器的使用

- 1) 電源適配器必須有患者監護人插拔使用
- 2) 治療器使用完畢後，請將電源適配器與220V電源斷電
- 3) 請勿使用非本機配備的電源適配器

故障排除

問題	原因	措施
向下撥動“電源開關”開不了機	電源接觸不良	檢查電源線與電源適配器及電源適配器與主機連接情況
訓練手套無法正常工作	訓練手套未正常接入治療器主機或訓練手套結構破損	檢查訓練手套物理狀態及治療器主機和訓練手套連接情況
治療器手套無法從治療器主機移除	訓練手套氣管接頭未旋轉擰出	將訓練手套氣管接頭逆時針旋轉擰出

注：用上述方法若仍舊無法正常使用時，請與節亮康復產品有限公司聯繫。



保養和維護

清潔消毒

- 訓練手套和鏡像手套請勿放到水裏浸泡清潔或放置到洗衣機內清洗，可將軟布蘸水或中性洗滌劑，充分擰幹後擦拭手套。必要時可用蘸取少量濃度為75%醫用酒精的抹布進行清洗或消毒，於陰涼通風處晾乾後再使用。
- 在治療器主機表面出現灰塵或污垢時，用戶可用濃度為75%醫用酒精擦拭。擦拭時請用乾爽的布蘸取少量酒精，避免讓酒精滴入或流入產品中。
- 用潔淨、乾爽的軟布清潔，陰涼通風處自然風乾。

⚠ 注意：

1. 使用酒精以外的清潔消毒劑可能損壞產品，縮短使用壽命或者導致安全風險。
2. 禁止使用高溫烘乾和放置於太陽下暴曬等進行速幹或消毒操作。
3. 不能使用汽油、稀釋劑或類似的有機溶劑對本產品的任何部位進行清洗。切勿使用放射、蒸汽、環氧乙烷等方法進行消毒，否則會造成產品損壞。

技術參數

產品規格

產品名稱	手部伸展復康治療器	進液防護程度	IPX0
產品型號	SAA-2	力度設定	1-5檔
安全類型	I 型	時間設定	5-60分鐘
電 源	AC100-240V, 50/60Hz	運行噪音	≤60分貝
主機尺寸	251*204*111mm	訓練模式	循環訓練 鏡像訓練 [®]

手套尺碼錶

尺碼	S	M	L	XL	XXL
手長 (mm)	140-160	160-180	165-190	190-220	220-230
手寬 (mm)	60-80	70-90	80-100	100-120	120-130
中指圍 (mm)	45-50	50-60	60-70	70-90	90-100

*可根據使用者實際手部量測情況選擇對應型號如兩個及以上測量值處於臨界點，建議選偏大一碼。

*女士一般選擇S/M, 男士一般選擇L/XL, 手大者XXL。

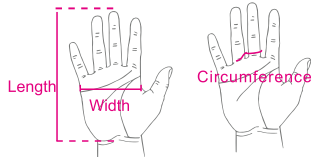

售後服務

售後電郵: info@ziglite.com

售後地址: 香港新界荃灣沙咀道364 - 366 號, 萬象工業大廈 18/F B3室

裝箱清單		
序號	名稱	數量 [®]
1	治療器主機	1臺
2	訓練手套	1隻
3	鏡像手套	1隻
4	電源適配器 電源線	1個
5	產品說明書	1份

Contents

Product introduction	02
User guide	04
Safety precautions	13
Safety precaution include	14
Troubleshooting	16
Technical parameters	17
After service	18



After service, Thank you for choosing the hand trainer.

Please read this manual carefully before using this product.

Please keep this manual properly for guidance when using the rehabilitation training device.

The Hand training device has two modes: the passive mode and Mirror Motion Rehabilitation Training Mode. Our device aims to maintain and expand the range of motion of finger joints, prevent joint contracture and muscle atrophy, greatly promote the reorganization and compensation of the nervous system, and help patients recover as soon as possible.

The recovery of hand dysfunction after stroke is a long-term and arduous process. Patients' conditions, rehabilitation courses, and curative effects are very different. Under normal circumstances, the recovery of hand function is slower than other parts, and long-term rehabilitation training is needed. If you have any questions in use, please get in touch with info@ziglite.com.

If you have any questions in use, please contact: info@ziglite.com

The manual version may upgrade due to changes in software version or technical specifications without prior notice.

Product Introduction

Scope Of Application

It is suitable for rehabilitation training in (families) institutions for patients with finger joint recovery after injury or limb dysfunction sequelae caused by brain injury, stroke, cerebral palsy, spinal cord injury, orthopedic surgery, multiple sclerosis, etc.

Product Composition

Trainer Host

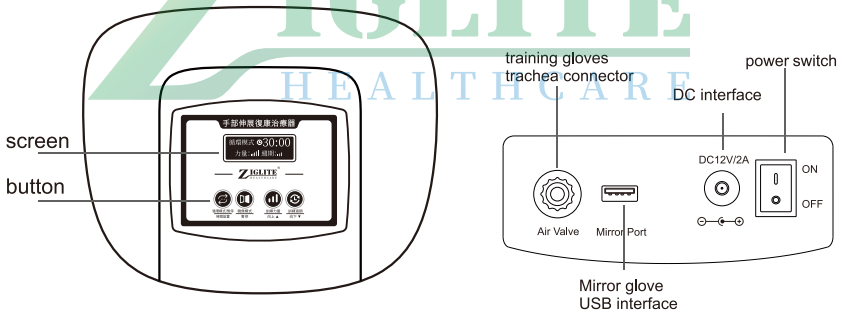

Product Introduction

Training Gloves

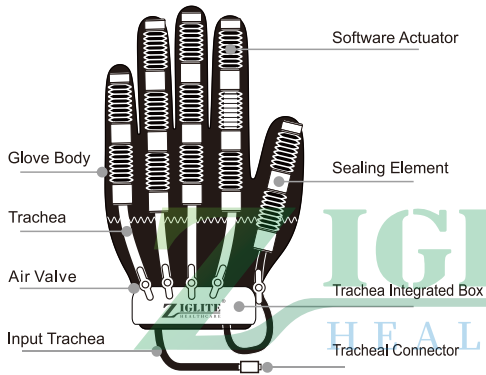

Mirror Glove

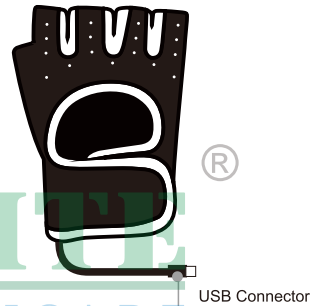

Power Adapter

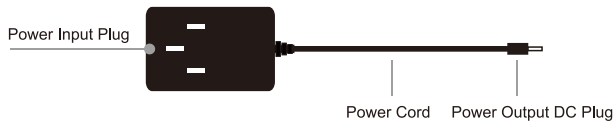

User Guide

Operation buttons and interface display

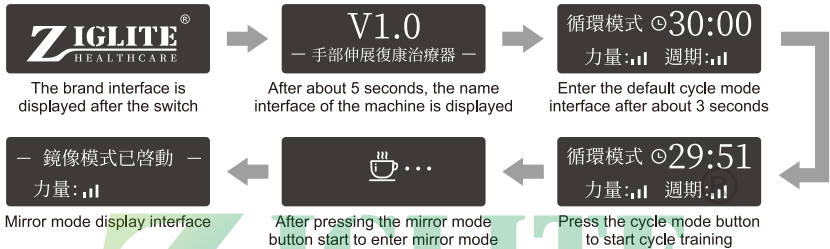

User Guide

Buttons, screen icons in detail

Cycle mode interface

循環模式
Training mode display

All finger cycle training is controlled by cycle keys.

力量: III
Training intensity display

The training strength is controlled by buttons, and the strength is displayed in 5 gears in total.

◎30:00
Training duration countdown display

The default startup time is set to 30:00 minutes, and the maximum can be set to 60:00 minutes. The training starts to count down, and the therapeutic device stops automatically after returning to zero.

週期: III
Training cycle display

The training cycle is controlled by pressing the key, and a total of 5 cycles are displayed.

1 Cycle mode Time setting

1) In the main interface, press this key once to enter the cyclic training mode. During the operation of this mode, press this key again to pause the training.
2) In training mode, long press the button for 3 seconds to enter the training time setting, with a maximum of 60 minutes.

2 Training intensity display

3 Training duration countdown display

4 Training cycle display

5 Cycle duration setting

1) Press this button to set the cycle time of one grasping and stretching training. The setting value is 1 ~ 5, a total of 5 gears.

6 Mirror mode

1) Press this button once to switch to the mirror training mode.

7 Power setting

1) Press the "training strength" button to set the training strength. The set values are: 1, 2, 3, 4 and 5, with a total of 5 levels of strength.

User Guide

Interface display details

Mirror mode display

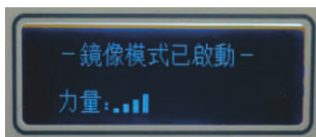

力量: . . . |

In the mirror image mode, press the “⏸” and “⌚” button to set the training intensity of the mirror image mode. There are 5 levels of intensity adjustment in total. 

Mirror mode
Power setting

Training time setting interface

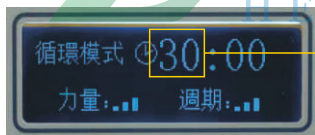

Time bit flashes

In the cyclic training mode, long press the “⌚” key for 3 seconds to enter the time setting mode, and the exercise time bit flashes.

The “⏸” and “⌚” keys can set the addition and subtraction of the training time. The minute setting division value is 5 minutes, and the training time can be up to 60 minutes.

User Guide

Use Guide



1 Place the therapeutic device host

Place the therapeutic device host on the desktop, not on the wet, soft cloth or unclean desktop.



2 Connect air pipe and DC plug

When the training gloves are connected, the trachea connector needs to be turned clockwise and tightened to the corresponding interface of the host.



3 Wear training (mirror) gloves

The guardian shall help the patient wear gloves and pull the glove Velcro to the wrist to bond and tighten.

User Guide

Use Guide

4



Power on

Turn down the "power switch" key of the therapeutic device host to the "I" position, power on and turn on, the LCD display will light up and enter.

5



Start hand training

Press the "cycle mode / mirror mode" button to start and pause training at any time.

6



Shut off

After the training, turn the "power switch" key of the therapeutic device host to the "O" position to turn off, and the LCD is powered off.

User Guide

Glove Wiring Diagram

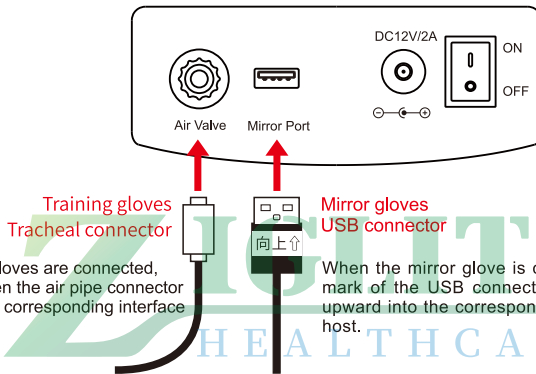

When training gloves are connected, rotate and tighten the air pipe connector clockwise to the corresponding interface of the host.

When the mirror glove is connected, the "↑" mark of the USB connector shall be inserted upward into the corresponding interface of the host.

Glove access effect



User Guide

Air Valve Switch Control

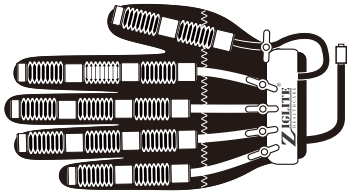

Each glove trachea of the training gloves is equipped with a single independent air valve switch, which can be turned on or off to carry out finger targeted selection training.



Open The Air Valve

The direction of the air valve is the same as that of the air pipe. The air valve is open, and the corresponding fingers can undergo rehabilitation training.

The air valve switch is on by default.



Close The Air Valve

The direction of the air valve and the air pipe is cross shaped, the air valve is closed, and the corresponding fingers are not trained.



User Guide











Cycle training

The circulation training mode adopts a fully automatic design. When the patient has no active control ability, it is recommended to use circulation training first, which will help to promote the recovery of flexor and extensor muscle strength of the affected hand, increase the joint's range of motion, and promote the emergence of active finger extension movement.

Default circuit training

<p>1</p> 	<p>1) Wear Training Gloves 2) After startup, enter the main training interface</p>	<p>2</p> 	<p>3) After power on, press to automatically enter the default cycle mode, press "↺" once to start training, the training duration is 30 minutes, and the cycle strength is the third gear.</p>
--	--	--	---





Force, cycle and time settings (Step 3 can be skipped without setting the time)

<p>(1)</p> 	<p>(2)</p> 	<p>(3)</p> 	<p>(4)</p> 
<p> Set training cycle</p> <p>Press 1 time to set the gear, 1 ~ 5 gears in total</p>	<p> Set training intensity</p> <p>Press 1 time to set the gear, 1 ~ 5 gears in total</p>	<p> Set training duration</p> <p>Press and hold for 3 sec to enter the setting, " " and " " control the addition and subtraction of time, and click addition and subtraction for 5 minutes each time.</p>	<p> Start training</p> <p>Press the button once to start training</p>

User Guide

Mirror training

Mirror mode refers to the mode that the patient drives the patient's hand to move synchronously through healthy hand movement. Through interactive visual feedback, it can stimulate different regions of the patient's brain to produce motor and sensory consciousness, start mirror neurons, and promote the reconstruction of motor function and brain function.

<p>(1)</p>  <p>Mirror glove Training gloves</p>	<p>(2)</p>  <p>ZHATEX TECHNICAL ZHATEX Mirror</p>	<p>(3)</p>  <p>ZHATEX TECHNICAL ZHATEX Intensity</p>	<p>(4)</p> 
<p>Wear gloves and turn on the machine</p> <ul style="list-style-type: none">● Wear training gloves on affected hands● Healthy hands wear mirror gloves● After startup, enter the main training interface	<p>Enter mirror mode</p> <p>In the main training interface, press "Mirror" once to enter the mirror training mode</p>	<p>Set training intensity</p> <p>Press "Intensity" once each time to set the training intensity, 1 ~ 5 gears in total</p>	<p>Start mirror training</p> <p>The healthy hand gives instructions for grasping (stretching) exercise, and the affected hand performs grasping (stretching) exercises according to the instructions</p> <p>Note: You need to grasp and press (release) the control button in the mirror glove to start the training glove grasp (release) action</p>

Safety Precautions

[warning] failure to comply with the following safety instructions may lead to serious accidents such as fire, electric shock and casualties.

- Do not disassemble, repair, or modify the components of the equipment by yourself to avoid abnormalities in the treatment device.
- Do not store components in or near water heaters, microwave ovens, cooking equipment, or high-pressure containers to avoid fire caused by overheating.
- It cannot be sterilized or autoclaved.
- Do not continue to use it when the alarm prompt appears.
- It is suitable for hand circulation and mirror movement rehabilitation training. Please do not use it for other purposes to avoid accidents.
- Do not store the parts in a place that is too hot or too cold to avoid accidents.
- The validity period of the product is 5 years, and the disposal of the product at the end of its service life should comply with the requirements of local laws and regulations.
- Please keep the power connector dry and water-free, please do not plug or unplug the power supply with wet hands to avoid electric shock or injury.

Working Environment

- 1) Ambient temperature: 10°C~35°C
- 2) Relative humidity: 30%~75%, excluding condensation
- 3) Atmospheric pressure range: 700hpa~1060hpa
- 4) Power supply: AC100-240V, 50/60Hz (main unit power supply of the treatment device DC12V)

Storage And Transportation

- During transportation, please fix the treatment device in a relatively stable place to prevent bumping and damage of the treatment device.
- Please prevent liquid or foreign objects from entering the treatment device to avoid damaging the internal electronic components and causing malfunctions.
- Do not store in a sterile gas or active gas environment to avoid damage to internal electronic components and cause malfunctions.
- Do not fold the gloves forcefully to avoid damaging the soft-actuated actuator and causing malfunctions.
- Do not store the therapy device in a humid environment or strong magnetic field interference and other environments that are not suitable for electronic equipment.

Safety Precaution Include

- In case of skin allergy and other discomfort during the use of the product, please stop using and consult a doctor.
- For patients with diseases or wounds or being treated for them, or with previous medical history, please consult a doctor after being familiar with the following contents.
- In case of sprain, trauma, bone injury of unknown condition, severe osteoporosis, untreated fracture or people who need bracing after treatment, do not use this product without professional confirmation.

Contraindication

- Patients with severe blood flow disorder such as thoracic venous tumor and hemocolumn disease;
- Patients with ulcer, wound, purulent fruit, bleeding, scald, inflammation, etc. on the affected hand. 

Other Precautions

- 1) In case of abnormal experience or body feeling during use, stop using it and use it under the guidance of a doctor after seeing a doctor;
- 2) In case of redness, pruritus and rash during use, stop use and seek medical attention;
- 3) Do not use it together with other equipment or in the state of applying drugs;
- 4) Do not use it alone for unconscious people or young children;
- 5) Do not use this product for any purpose other than the purpose of use.

Before Use

- 1) Before wearing training gloves, please try to run the therapeutic device host for 1 minute to confirm that all parts function normally;
- 2) Patients with mandatory systolic spasm need to massage before using the therapeutic device;
- 3) Note: before training, please confirm that the non muscle tension of the hand to be trained is too high (above grade II).

Safety Precaution Include

In Use

In case of the following conditions during operation, please stop using immediately and disconnect the power supply.

- 1) The main machine of the trainer makes abnormal sound
- 2) The surface temperature of the trainer is too high
- 3) The main machine of the trainer is flooded
- 4) The user feels pain, swelling or other discomfort symptoms
- 5) If spasm occurs during training, stop using it immediately

Usage Time

- 1) It is suggested to select appropriate training methods according to their own actual situation
- 2) The time of each use should not be too long. If the hand feels sore the next day after training, it is necessary to reduce the number and time of daily training
- 3) It is recommended to use 2-4 times a day for about 20 minutes each time, with an interval of at least 45 minutes
- 4) If you need to change or extend the use time, please consult professional medical personnel

Use Of Power Adapter

- 1) The power adapter must be plugged in and out by the patient's supervisor
- 2) After using the therapeutic device, please cut off the power adapter and 220V power supply
- 3) Do not use a power adapter that is not provided with this machine

Troubleshooting

Problem	The Reason	Measures
Flip the "power switch" down to turn on the machine	Poor power connection	Check the power cord and power adapter, the connection between the power adapter and the host
Training gloves are not working	Gloves that are not properly attached can damage the host or glove structure	Check the physical status of the training gloves, the connection between the treatment device and the training gloves
The treatment gloves are not installed or removed from the treatment device	The air pipe connector of training gloves is not rotationally installed (screwed out)	Rotate the tracheal connector of the training glove counterclockwise to insert (remove)

Note: If you still can't use the above method, please contact us. 

Care And Maintenance

Clean And Disinfect

- Do not wash training gloves and mirrored gloves directly with water. Dip a soft cloth in water or neutral detergent, wring it out, and wipe the gloves. If necessary, use a rag with a concentration of 75% medical alcohol for cleaning or disinfection, and then use it after it is completely dried.
- When there is dust or dirt on the surface of the main body of the treatment device, the user can wipe it with 75% medical alcohol. When wiping, please use a dry cloth dipped in a small amount of alcohol to avoid dripping or flowing into the product.
- Clean with clean and dry soft cloth, and dry in a cool and ventilated place.

Note

1. The use of cleaning and disinfecting agents other than alcohol may damage the product, shorten the service life or cause safety risks.
2. It is forbidden to use high-temperature drying and exposure to the sun for quick drying or disinfection.
3. Do not use gasoline, thinner or similar organic solvents to clean any part of this product. Do not use radiation, steam, ethylene oxide and other methods for disinfection, otherwise the product will be damaged.

Technical Parameters

Product Specifications

Product Name	Hand Stretching Rehabilitation Therapy Device	Waterproof Level	IPX0
Product Model	SAA-2	Velocity Setting	1-5
Security Type	I Type	Time Setting	5-60 minutes
Power Supply	AC100-240V 50/60Hz	Running Noise	≤60dB
Host Size	251*204*111mm	Training Mode	Cycle training/ Mirror training [®]

Z IGLITE
HEALTH CARE

Glove Size

Size	S	M	L	XL	XXL
Hand length (mm)	140-160	160-180	165-190	190-220	220-230
Hand width (mm)	60-80	70-90	80-100	100-120	120-130
Middle finger circumference (mm)	45-50	50-60	60-70	70-90	90-100

* The corresponding model can be selected according to the user's actual hand measurement situation.

If two or more measured values are at the critical point, it is recommended to choose one yard larger.

* Women generally choose s/m, men generally choose l/xl, and the larger hand is XXL.

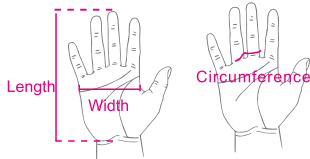

After service

After sales email : info@ziglite.com

After sales address : Room B3, 18/F Bonsun Industrial Building,
364-366 Sha Tsui Road, Tsuen Wan, Hong Kong

Packing List		
Number	Name	Quantity
1	Therapeutic device host	1 set
2	Training gloves	1 set
3	Mirror gloves	1 set
4	Power adapter, power cord	1 set
5	Product specification	1 set



Ziglite Smart Health Care Products Co., Ltd.
節亮康護產品有限公司

Office Address : Room B3, 18/F Bonsun Industrial Building, 364-366 Sha Tsui Road, Tsuen
Wan, Hong Kong

Email : info@ziglite.com

Fax: +852 3544 0462

Office : +852 3974 5593

Whatsapp : +852 6756 7703

Wechat ID : Gg971213, helen-3110

NO. A02-CH-EN